

3 BOYUTLU GENEL GÖRÜNÜŞ

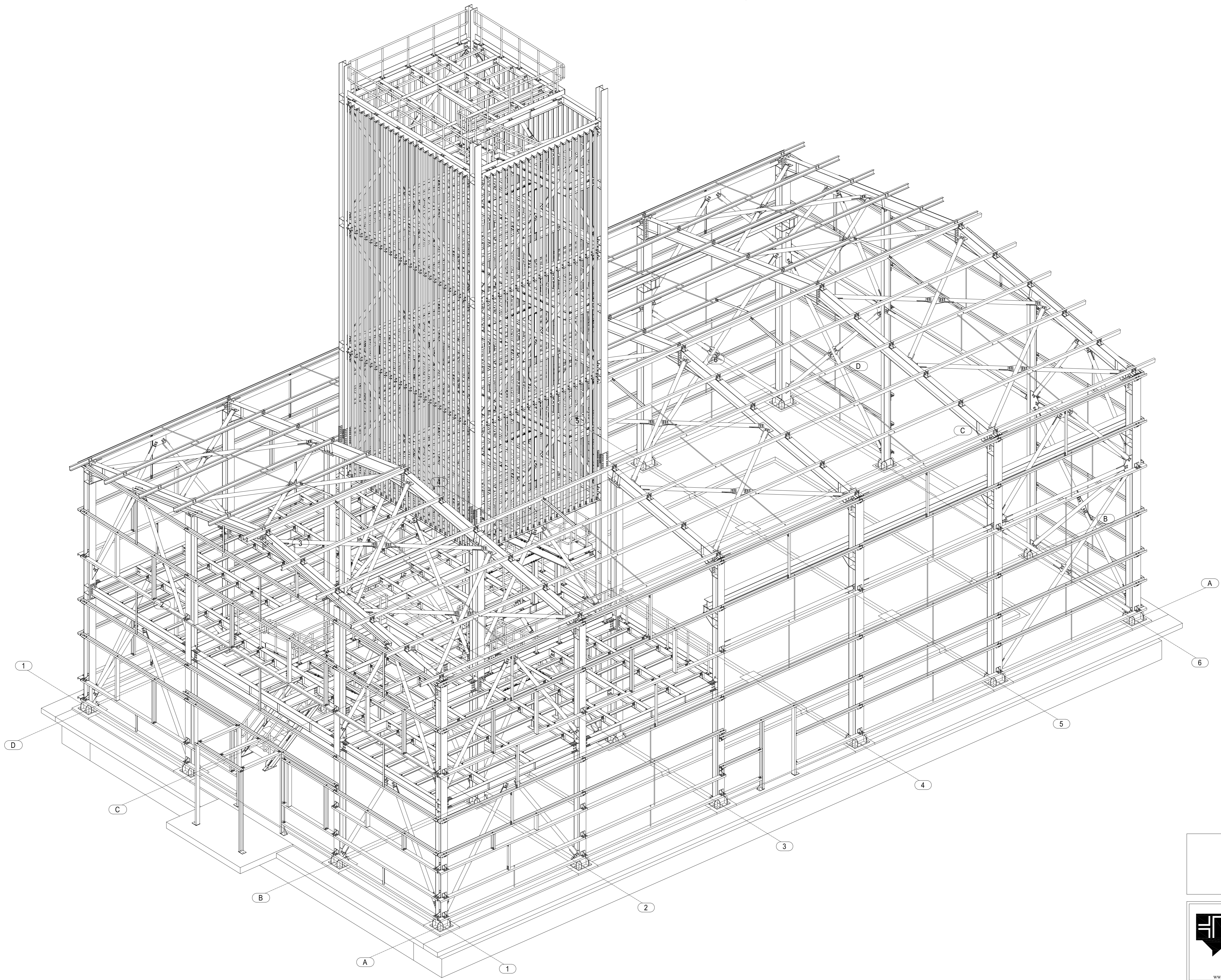

GENEL PROJE NOTLARI

- BU PROJE MİMARİ, TESİSAT VE ELEKTRİK PROJESİ İLE BİRLİKTE UYGULANACAKTIR.
- 5,00 m'DEN BÜYÜK KIRIŞ DÖŞEME ve DÖŞEME KIRIŞLARININ 360 cm. TERS SEHİM UYGULANACAKTIR.
- KONSOL DÖŞEMELERDE ve KIRIŞLARDA 150 cm. TERS SEHİM UYGULANACAKTIR.
- DÖŞEMEDeki YIRTIKLAR VE BACA YERLERİ MİMARİ VE TESİSAT PROJESİNDEN ALINACAKTIR.
- DÖŞEMEDeki YIRTIKLAR İÇİN 2x 2x14 İLAVE DONATI KONACAKTIR.
- İSLAK HACİMLERDEKİ SUYUN BETONA DEĞMEMESİ İÇİN GEREKEN YALITIMLAR YAPILMALIDIR.
- ŞANITVE ŞEFİ ve YAPI DENETİM MÜHENDİSİ KONTROL ETMEDEN BETON DÖKÜLEMEZ.
- YAĞMUR SUYUNDAN BİNAYI KORUMAK İÇİN YALITIM ve DRENAJ YAPILMALIDIR.
- BETON DÖKÜLDÜREN BETONUN YERLEŞMESİ İÇİN VİBRATÖR KULLANILMALIDIR.
- BETON DÖKÜLDÜKTEN 1 SAAT SONRASINDAN İTİBAREN 7 GÜN SÜREYLE İLK 3 GÜNÜ SÜREKLİ SONRAKİ GÜNLER SABAH,ÖĞLEN,AKŞAM BÖL BÖL SULANMALIDIR. MÜMKÜNSE KÜR YAPILARAK BETON NEMLİ TUTULMALIDIR.
- BETON DÖKÜLMEDEN ÖNCE KALIPLAR BASINÇLI SU İLE TEMİZLENİP ADEYERANSI ENGELLEYEN TAHTA, TALAŞ VB. MADDELERDEN ARINDIRILMALIDIR.
- DÜŞÜK DÖŞEMELERDE GAZBETON MOLOZU GİBİ HAFIF MALZEME İLE DOLDURULACAKTIR.
- DUVAR VE ASMÖLEN BLOKLAR İÇİN İSİ İZOLASYONU YÜKSEK HAFIF AĞIRLIKLI MALZEMELER KULLANILMALIDIR
- İNŞAATIN BÜTÜN BÖLÜMLERİNDE PASPAYI KULLANILACAK (TEMEL-KOLON-KIRIŞ-DÖŞEME)
- BÜTÜN DEMİRLER TEK TEK BAĞLANACAK.
- DEMİR ARALIKLARI DEMİR ORTASINDAN DEMİR ORTASINADIR.
- PLAK DÖŞEMELERDE ALT DONATI ARALIĞI MESNETDE ve AÇIKLIKTA 20 cm GEÇEMEZ. (PİLYE ALTI MONTAJ DEMİRİ 10/25 İLAVE OLARAK KONULACAKTIR.
- BÜTÜN ÖLÇÜLER cm. KOTLAR metredir.
- PASPAYI: TEMEL ve TEMEL KIRIŞLARINDE : 5cm PERDELERDE (zeminle temasta olan yüzeylerde) : 4cm (zeminle temasta olmayan yüzeylerde) : 2.5cm KOLONLARDA KIRIŞLARDA : 3cm DÖŞEMELERDE : 2.5cm
- TEMEL İÇİN BETON SLUMP DEĞERİ : 16-17cm
- KOLON-PERDE-KIRIŞ İÇİN BETON SLUP DEĞERİ : 16-17cm

DEMİR BÜKÜM DETAYI

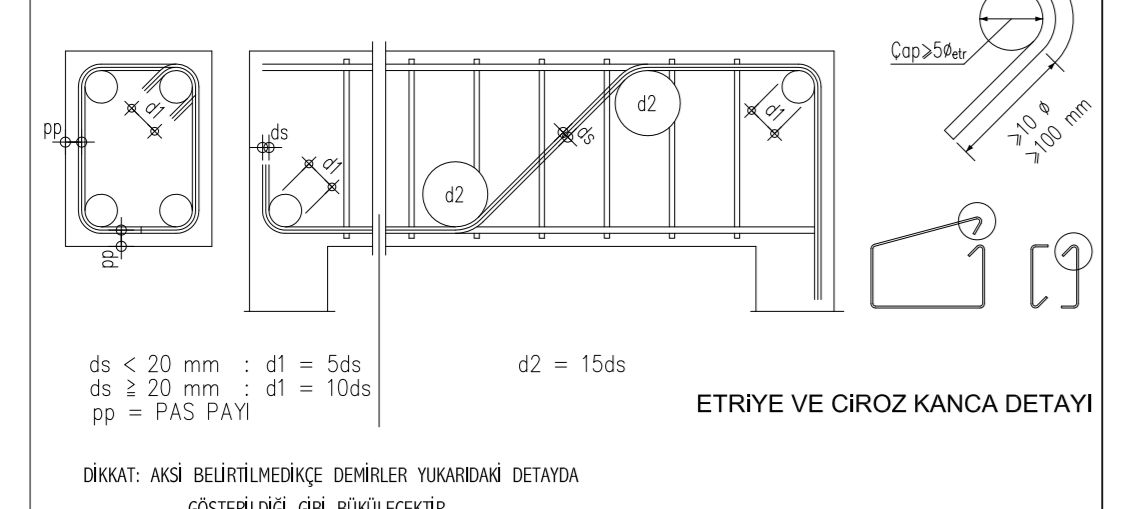

STATİK ve BETONARME PROJE

BurTem İnşaat Taah. Proje ve Müh. San. Ltd. Sti.
 Tel : +90 216 349 98 82
 Fax : +90 216 349 93 59
 www.burtem.com
 Dumanlıyaka İkon A3/107
 ATASEHİR / İSTANBUL

PROJE MÜELLİFİ	İMÖ SİCİL NO	PROJE MÜELLİFİ ONAYI
	İTİB TESCİL NO	
	DİPLOMA NO	
	BEL. SİCİL NO	
BETONARME ve STATİK PROJELER 06.03.2007 TARİHİ VE 29454 SAYILI RESMİ GAZETEDE YAYINLANAN DEĞİRMEN BİLGİLERİNDE YAPILACAK BİNALAR HAKINDA YÖNETMELİK HÜKÜMLERİNE GÖRE HAZIRLANMIŞ OLAN ÖLÇÜ, ÇİZİM, TASAARIM VE HESAPLARDAN DOĞACAK MESULİYET PROJESİ MÜELLİFİ OLARAK TARAFIMADIR.		
YAPI SAHİBİ	KULLANIM AMACI	İŞ YERİ BLOK ADI
İLİ	PAFTA NO	
İLÇESİ	ADA NO	
MAHALLE	PARSEL NO	
YAPI DENETİM KURULUŞU ONAYI	BELEDİYE TESCİLİ	
Belediye Başkanlığı İmar ve Şehircilik Müdürlüğü/20.../... Tarh... sayılı proje mülkiyet İBB sicil no ile Tescil Edilmiştir. Rpt. Şef	
STATİK RAPORTÖR	ZEMİN RAPORTÖR	STATİK VE TESİSAT ŞEFİ İMAR VE ŞEHİRCİLİK MÜDÜRÜ

İNHAAT ALANI	YAPILANIN KATLARI	KAT ADI	TARİHİ	SİSTEMİ	BOYUTU	YERİ	İSİ	YERİ	YERİ	YERİ	YERİ	YERİ
ZEMİN YAT KATLARI	ZEMİN DİNE	ZEMİN DİNE	ZEMİN DİNE	ZEMİN DİNE	ZEMİN DİNE	ZEMİN DİNE	ZEMİN DİNE	ZEMİN DİNE	ZEMİN DİNE	ZEMİN DİNE	ZEMİN DİNE	ZEMİN DİNE
ZEMİN DİNE	ZEMİN DİNE	ZEMİN DİNE	ZEMİN DİNE	ZEMİN DİNE	ZEMİN DİNE	ZEMİN DİNE	ZEMİN DİNE	ZEMİN DİNE	ZEMİN DİNE	ZEMİN DİNE	ZEMİN DİNE	ZEMİN DİNE
ZEMİN DİNE	ZEMİN DİNE	ZEMİN DİNE	ZEMİN DİNE	ZEMİN DİNE	ZEMİN DİNE	ZEMİN DİNE	ZEMİN DİNE	ZEMİN DİNE	ZEMİN DİNE	ZEMİN DİNE	ZEMİN DİNE	ZEMİN DİNE

STATİK ve BETONARME PROJESİ MÜELLİFİ BURTEM İNŞAAT TAHAH. PROJE VE MÜH. SAN. LTD. STİ.

KASE-İMZA			
PROJE	ÜNVAN	ADI SOYADI	KASE-İMZA
YAPAN	YÖK.İNS.MÜH.	---	
ÇİZEN	YÖK.İNS.MÜH.	---	
KONTROL	YÖK.İNS.MÜH.	---	

PAFTA NO :	01	PROJE ADI :	
ÖLÇEK :	1/50		
TARİH :	???????????????		
PAFTA ADI :	3 BOYUTLU GENEL GÖRÜNÜŞ		

İNCELEME:			
ONAY:			
REV.	AÇIKLAMA	TARİH	KONTROL İMZA

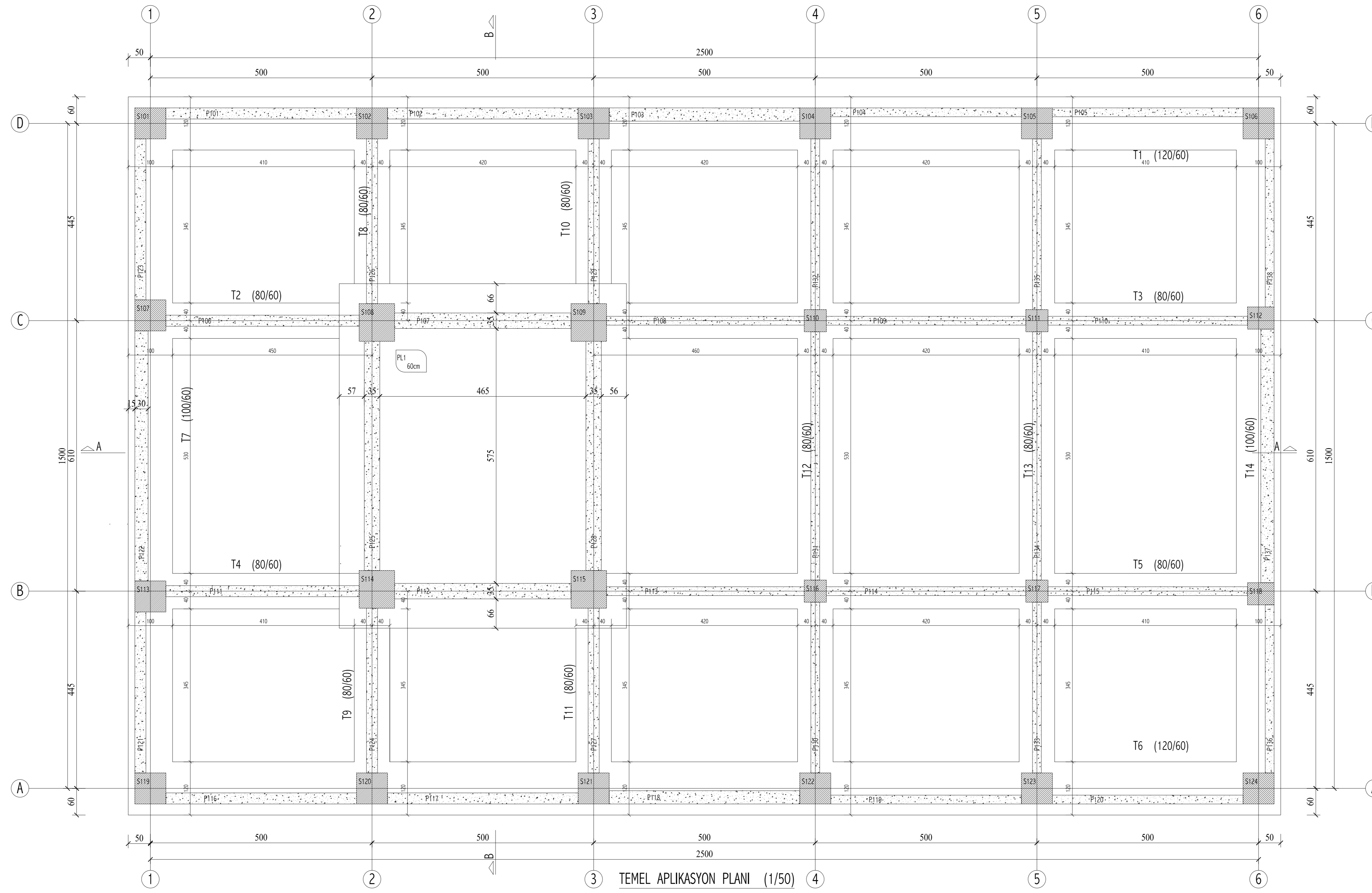

B-B TEMEL KESİTİ (1/50)
(İncek. 68m)

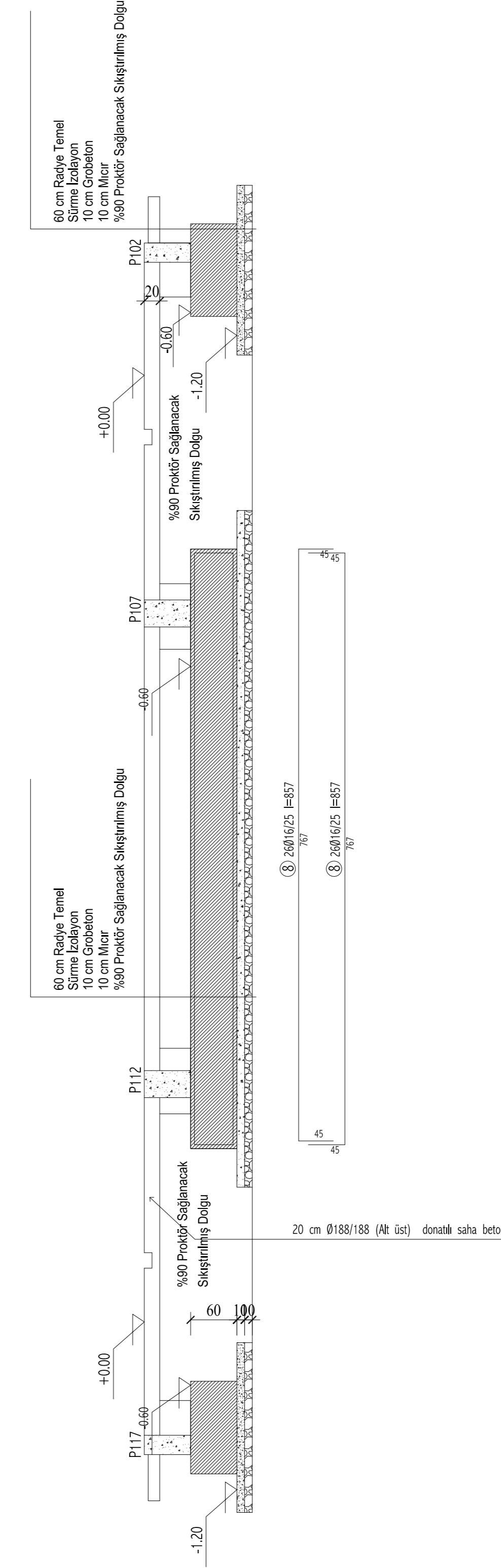

A-A TEMEL KESİTİ (1/50)

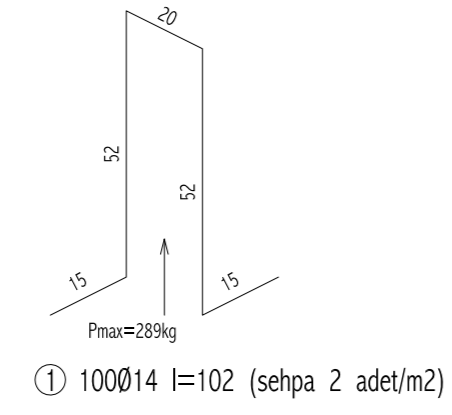
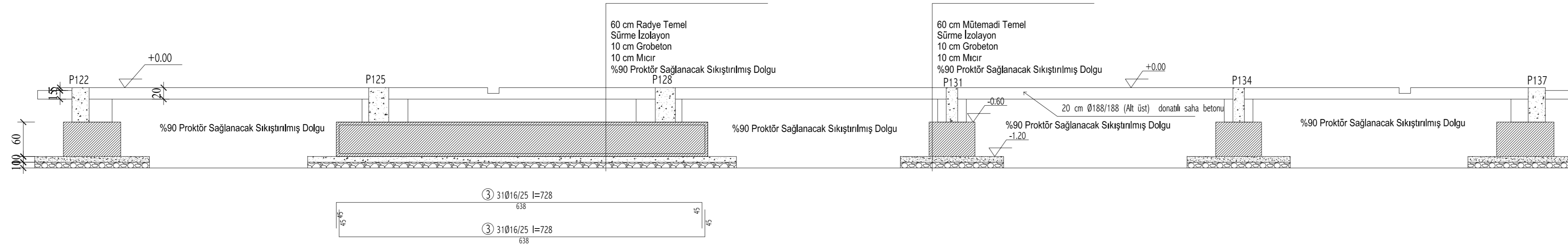

① 100Ø14 I=102 (setpa 2 adet/m²)

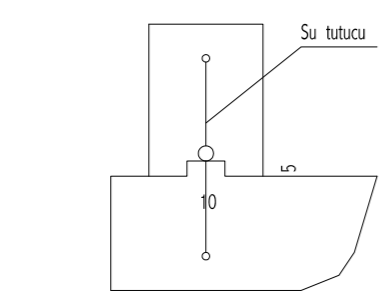

TİRKİ BODRUM PERDESİ İNŞAAT DERZİ DETAYI

NOT: TOPRAKLA TEMAS EDEN TÜM BETONARME YÜZEYLERDE SÜRME İZOLASYON KULLANILACAKTIR.

RADYE TEMEL METRAJ

Ø 6-12 (kg)	: 0.00
Ø 14-50 (kg)	: 1537.40

MALZEME

BETON SINIFI : C30 (f_{ck}:30MPa)

ÇELİK SINIFI : S420 (f_{yk}:420MPa)

Zemin taşıma kapasitesi : 2470 kN/m²

Zemin emniyet gerilmesi : 120 kN/m²

Ao I R Ia Ib Zemin Pasajı
0.4 1.0 6.0 0.15 0.6 Z3 5cm

ADET	POZ	ÇAP	BOY	AGIRLIK
52	P08	Ø16	857	702.7
62	P03	Ø16	728	711.7
100	P01	Ø16	102	123.0

KAŞE-İMZA			
PROJE	ÜNVAN	ADI SOYADI	KAŞE-İMZA
YAPAN	YÖK.İNŞ.MH.	_____	
ÇİZEN	YÖK.İNŞ.MH.	_____	
KONTROL	YÖK.İNŞ.MH.	_____	

PAFTA NO :	02	PROJE ADI :	
ÖLÇEK :	1/50		
TARİH :	????????????		
PAFTA ADI :	TEME L APLIKASYON PLANI , RADYE TEMEL DONATI DETAYI		

REV.	AÇIKLAMA	TARİH	KONTROL	İMZA

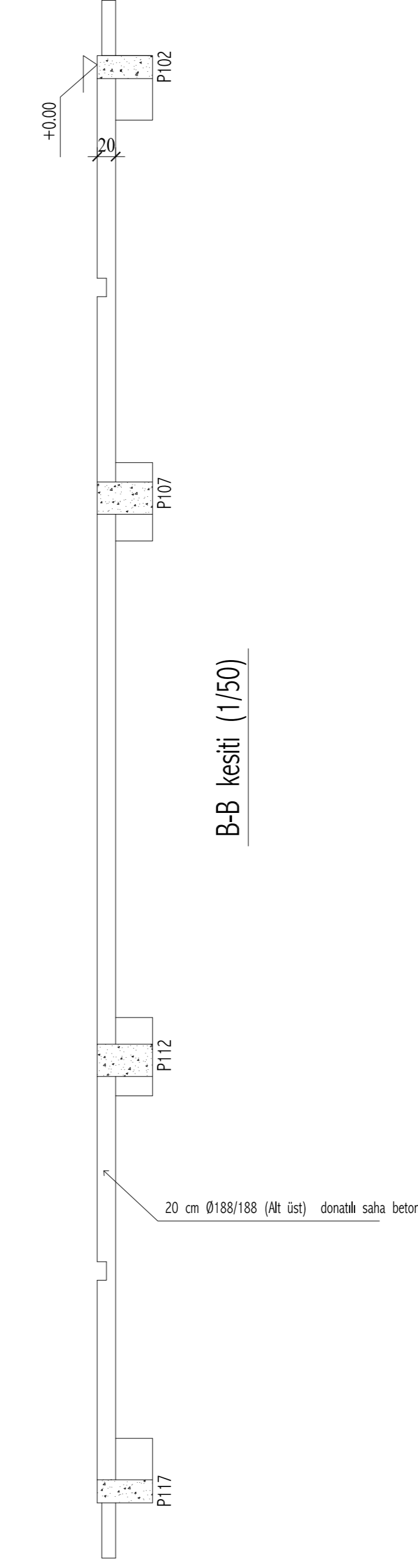
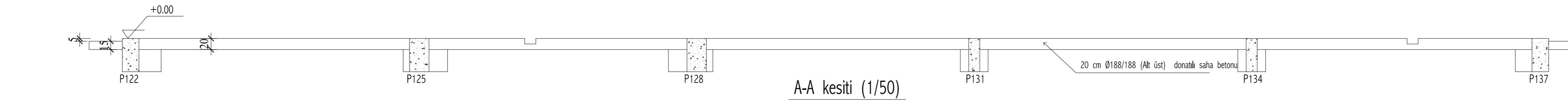
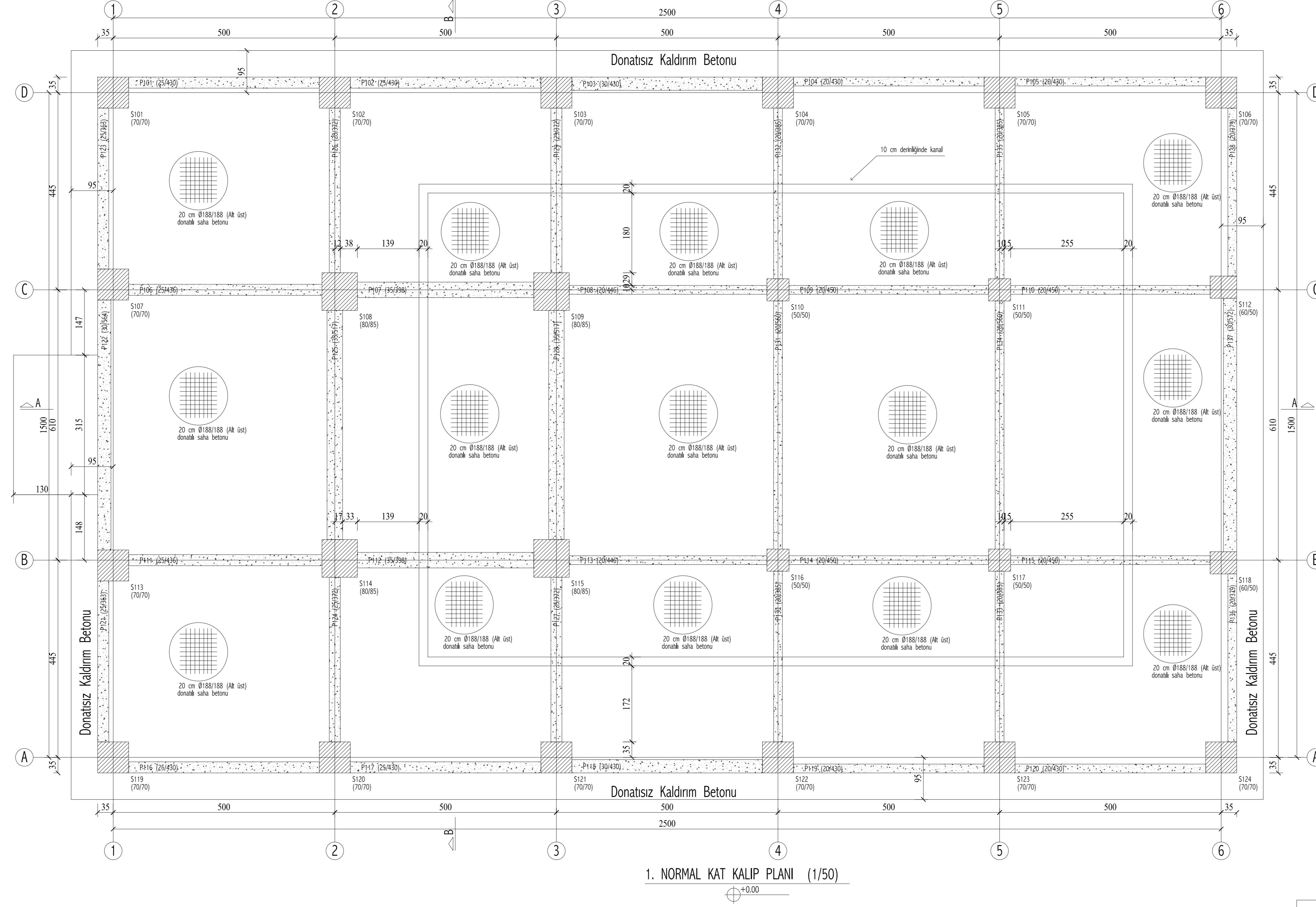

MALZEME						
BETON SINIFI	: C30 (fck:30MPa)					
CELİK SINIFI	: S420 (fyk:420MPa)					
A ₀	1	R	1a	1b	Zemin	Plasajı
	0,4	1,0	6,0	0,15	0,6	23
						1,5cm

KASE-İMZA			
<p>BurTem İnşaat Taahhüt, Proje ve Müh. San. Ltd. Şti. Tel: +90 216 349 98 82 Eks: +90 216 349 98 89 ATAŞEHİR / KADIKÖY www.burtem.com info@burtem.com</p>	PROJE YAPAN	ÜNVAN	ADI SOYADI
	ÇİZEN	YÖK.İNŞ.MDH.	_____
	KONTROL	YÖK.İNŞ.MDH.	_____
KASE-İMZA			

PAFTA NO :	03	PROJE ADI :
ÖLÇEK :	1/50	
TARİH :	????????????	
PAFTA ADI :	1. NORMAL KAT KALIP PLANI	

İNCELEME:
ONAY:

REV.	AÇIKLAMA	TARİH	KONTROL	İMZA

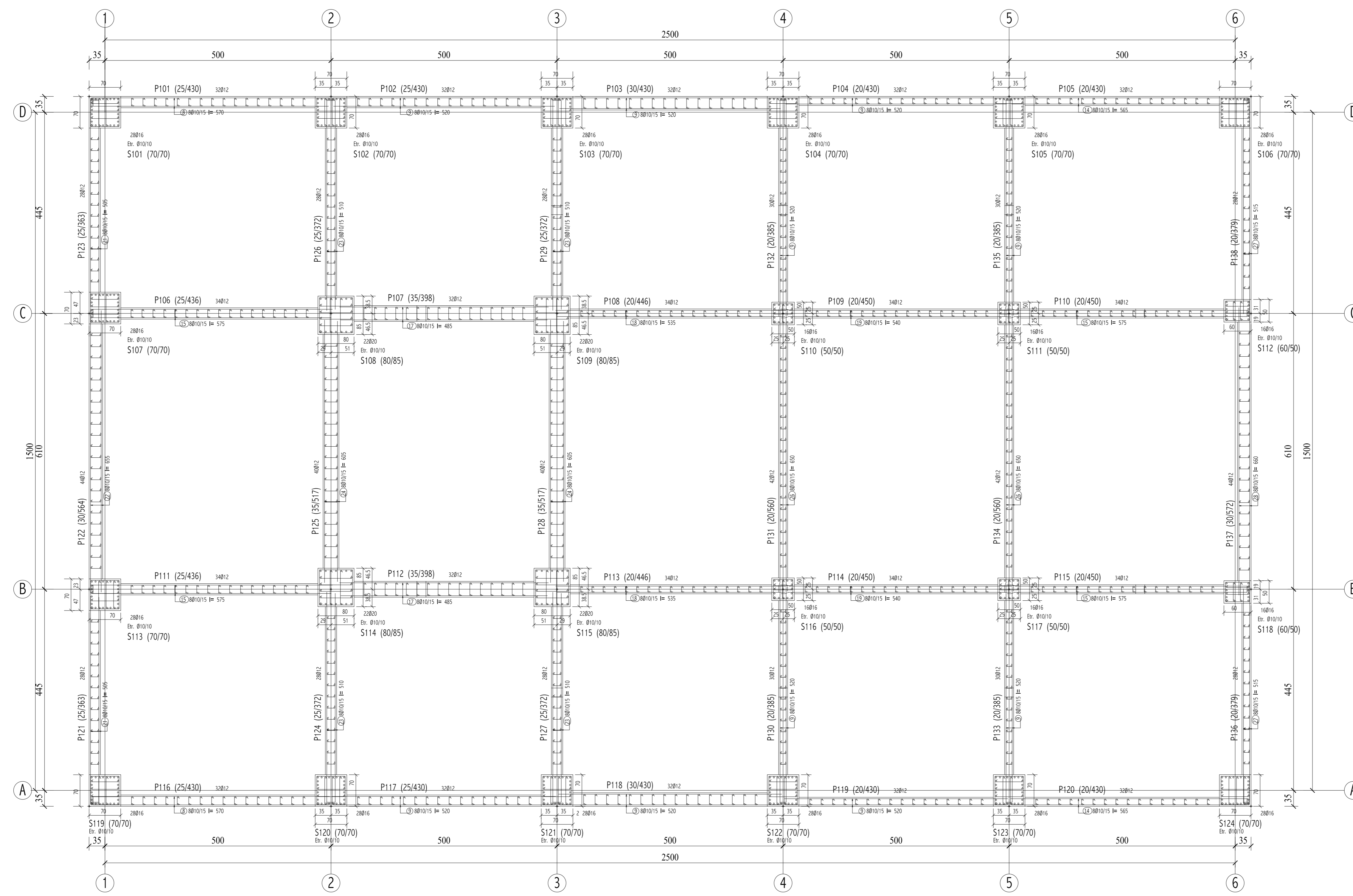

Çizim No	Boyut	Çizim Adı
S101	Ø110	180x180
S102	Ø110	180x180
S103	Ø110	180x180
S104	Ø110	180x180
S105	Ø110	180x180
S106	Ø110	180x180
S107	Ø110	180x180
S108	Ø110	180x180
S109	Ø110	180x180
S110	Ø110	180x180
S111	Ø110	180x180
S112	Ø110	180x180
S113	Ø110	180x180
S114	Ø110	180x180
S115	Ø110	180x180
S116	Ø110	180x180
S117	Ø110	180x180
S118	Ø110	180x180
S119	Ø110	180x180
S120	Ø110	180x180
S121	Ø110	180x180
S122	Ø110	180x180
S123	Ø110	180x180
S124	Ø110	180x180
P101	Ø110	180x180
P102	Ø110	180x180
P103	Ø110	180x180
P104	Ø110	180x180
P105	Ø110	180x180
P106	Ø110	180x180
P107	Ø110	180x180
P108	Ø110	180x180
P109	Ø110	180x180
P110	Ø110	180x180
P111	Ø110	180x180
P112	Ø110	180x180
P113	Ø110	180x180
P114	Ø110	180x180
P115	Ø110	180x180
P116	Ø110	180x180
P117	Ø110	180x180
P118	Ø110	180x180
P119	Ø110	180x180
P120	Ø110	180x180
P121	Ø110	180x180
P122	Ø110	180x180
P123	Ø110	180x180
P124	Ø110	180x180
P125	Ø110	180x180
P126	Ø110	180x180
P127	Ø110	180x180
P128	Ø110	180x180

NO	ÇİZİM ADI	ÇAP	BOY	ADET	TOPLAM BOY
112	P17	Ø110	53	1	36.5
592	P16	Ø110	38	1	138.5
152	P15	Ø110	48	1	44.9
364	P14	Ø110	43	1	96.4
12	P13	Ø110	79	1	5.8
48	P12	Ø110	69	1	20.4
48	P11	Ø110	99	1	29.2
24	P10	Ø110	104	1	15.3
210	P29	Ø110	89	1	115.1
8	P28	Ø110	650	1	32.5
16	P27	Ø110	515	1	50.7
16	P26	Ø110	650	1	64
32	P25	Ø110	520	1	102.5
16	P24	Ø110	855	1	596
32	P23	Ø110	510	1	100.5
8	P22	Ø110	655	1	32.2
16	P21	Ø110	505	1	49.7
16	P20	Ø110	575	1	56.6
16	P19	Ø110	540	1	52.2
16	P18	Ø110	535	1	52.7
16	P17	Ø110	485	1	47.8
32	P15	Ø110	575	1	113.3
16	P14	Ø110	565	1	55.6
16	P13	Ø110	520	1	51.2
16	P11	Ø110	520	1	51.2
80	P09	Ø110	520	1	256.2
16	P08	Ø110	570	1	56.1
16	P06	Ø110	220	1	21.6
32	P05	Ø110	200	1	29.3
32	P03	Ø110	330	1	64.9
84	P01	Ø110	280	1	193.1

1. NORMAL KAT KOLON APLİKASYON PLANI (1/50)

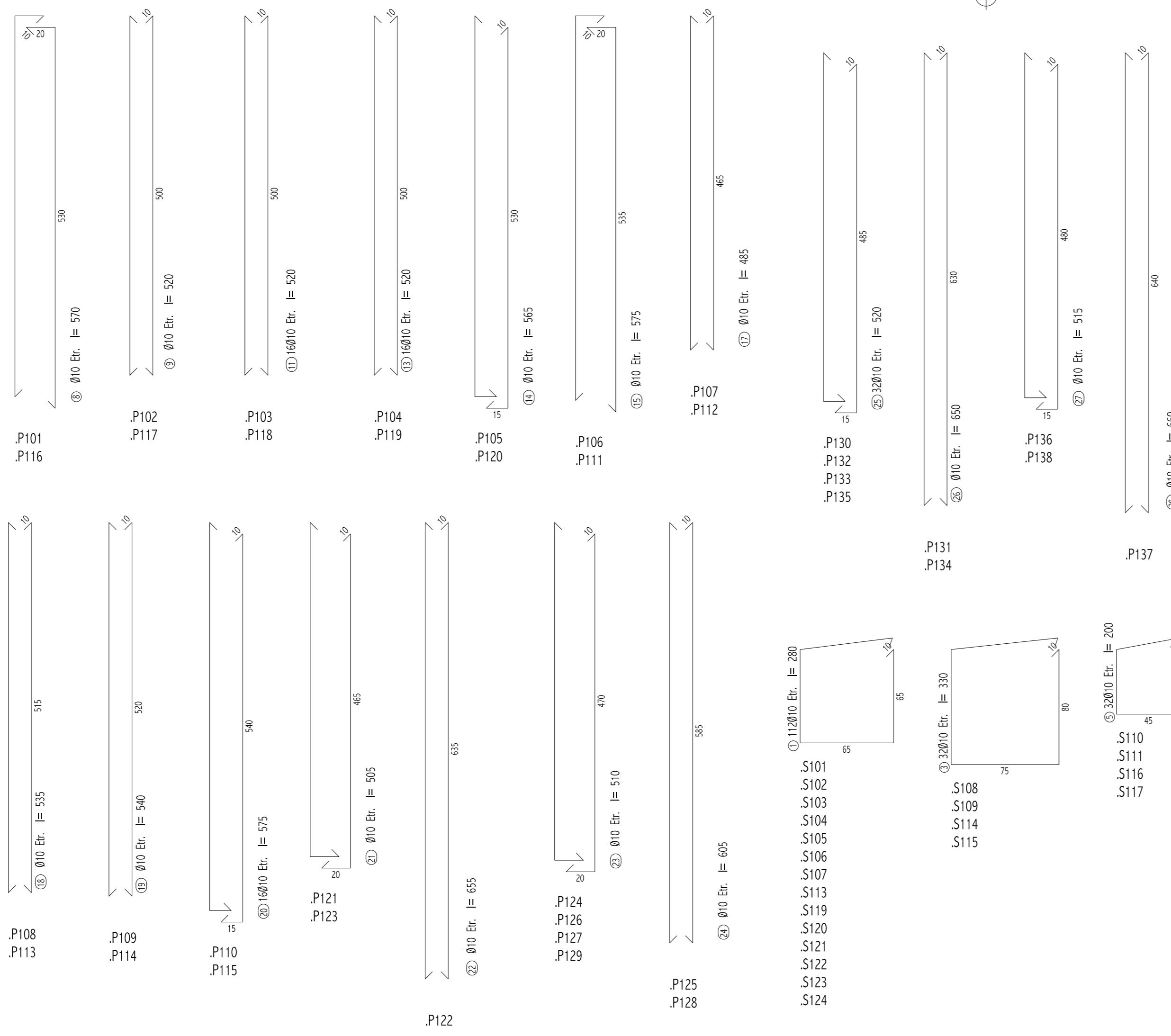

ÇELİK HASIR METRAJ
Ø 188/188 (kg) : 2426.06

KOLON-PERDE ENİNE DONATI METRAJ
Ø 6-12 (kg) : 2116.60
Ø 14-50 (kg) : 0.00

TOPLAM BETON METRAJ
221.55 m³

TOPLAM KALIP METRAJ
425.38 m²

MALZEME

BETON SINIFI	: C30 (fck:30MPa)
ÇELİK SINIFI	: S420 (fyk:420MPa)
A ₀	1.0
R	6.0
T _a	0.15
T _b	0.6
Z ₃	23
Papgeç	2.5cm

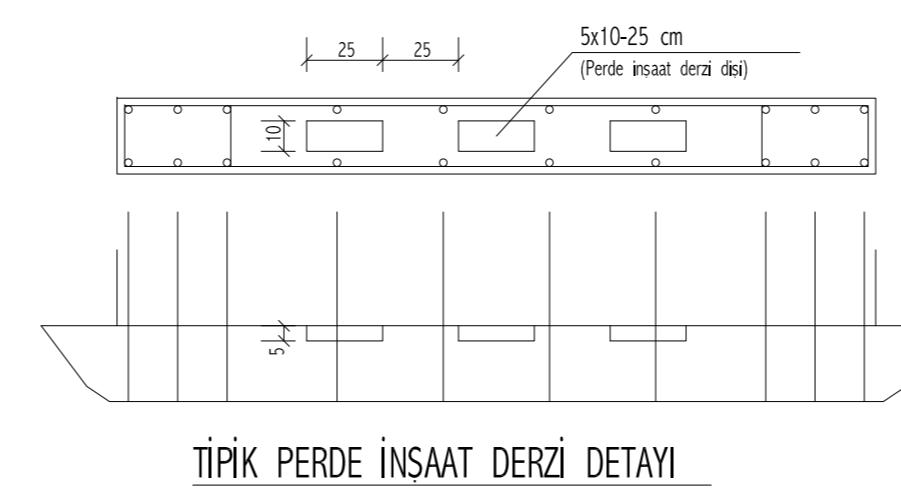

TİPİK PERDE İNŞAAT DERZİ DETAYI

KAŞE-İMZA	
	PROJE ÜNVAN ADI SOYADI
YAPAN	YÖK.İNS.MÜH.
ÇİZEN	YÖK.İNS.MÜH.
KONTROL	YÖK.İNS.MÜH.
PAFTA NO : 04	PROJE ADI :
ÖLÇEK : 1/50	
TARİH : ???????????	
PAFTA ADI : 1. NORMAL KAT KOLON APLİKASYON PLANI	
İNCELEME:	
ONAY:	
REV. AÇIKLAMA	TARİH KONTROL İMZA

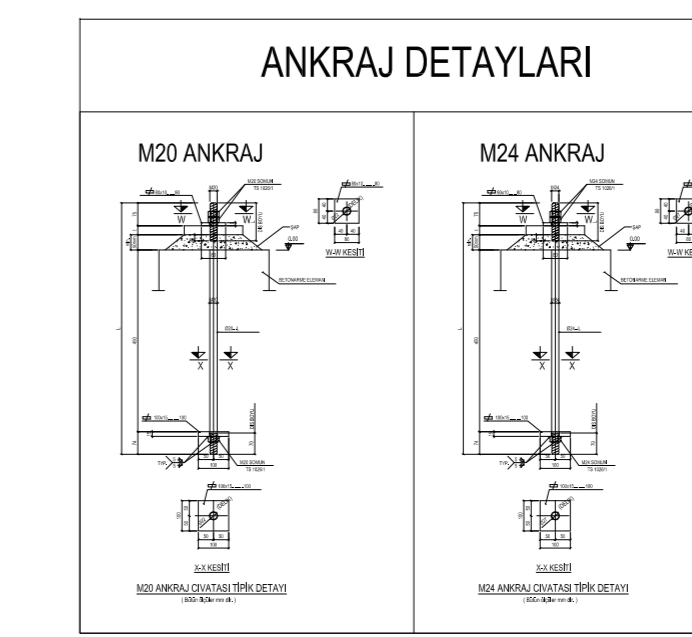
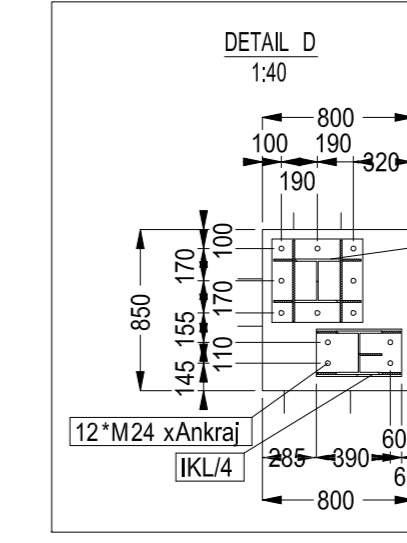
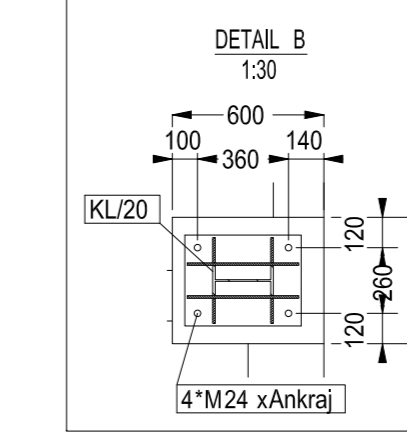
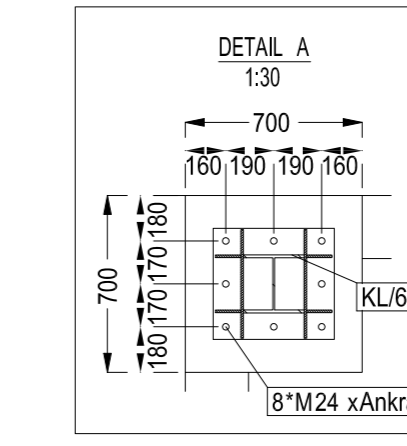
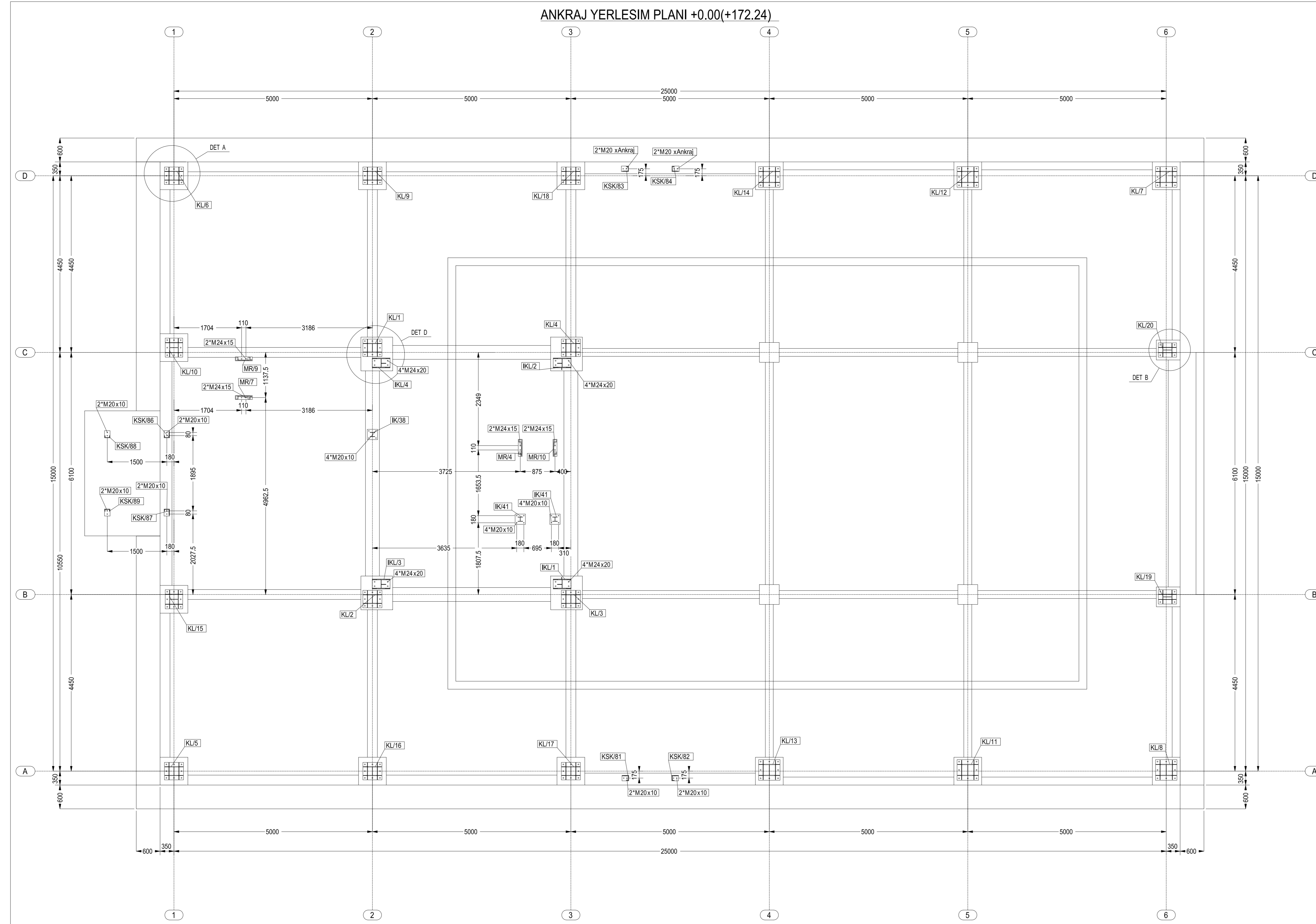

				KAŞE-İMZA
 <p>BurTem İnşaat Taah. Proje ve Müh. San. Ltd. Şti. Tel: +90 216 349 98 82 Fax: +90 216 349 91 59 ATAŞEHİR - KADIKÖY www.burtem.com info@burtem.com</p>	PROJE	ÜNVAN	ADI SOYADI	KAŞE-İMZA
	YAPAN	YÖK.İNŞ.İM.ÖH.	_____	
	ÇİZEN	YÖK.İNŞ.İM.ÖH.	_____	
	KONTROL	YÖK.İNŞ.İM.ÖH.	_____	

PAFTA NO :	06	PROJE ADI :	
ÖLÇEK :	1/50		
TARİH :	????????????		
PAFTA ADI :	ANKRAJ YERLEŞİM PLANI		

İNCELEME:

ONAY:

REV.	AÇIKLAMA	TARİH	KONTROL	İMZA

PLAN +4.00 DÖŞEME SAC YERLEŞİMİ

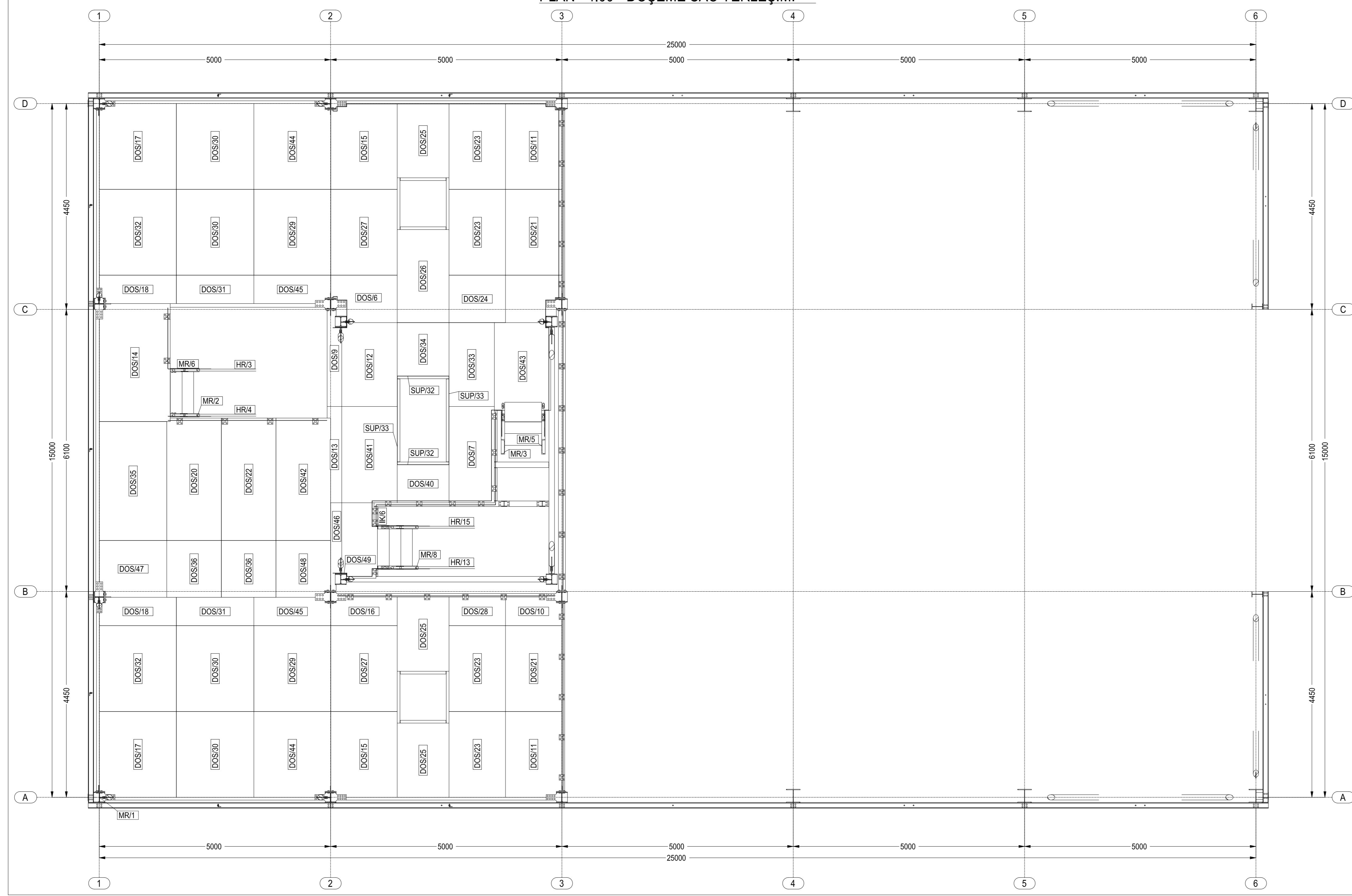

PLAN +4.00 ÇELİK YERLEŞİM



				KAŞE-İMZA	
				KAŞE-İMZA	
 <p>BurTem İnsaat Tarih, Proje ve Müh. San. Ltd. Şti. Tel : +90 216 349 98 82 Fax : +90 216 349 93 59 ATAŞEHİR - KÜLTÜRÇY www.burtem.com info@burtem.com</p>	PROJE YAPAN	ÜNVAN	ADI SOYADI		
	ÇİZEN				
	KONTROL				
	PROJE ADI :				
PAFTA NO :	07				
ÖLÇEK :	1/50				
TARİH :	????????????				
PAFTA ADI :	PLAN +4.00 KOTU DÖŞEME SAC VE ÇELİK YERLEŞİMİ				
İNCELEME:					
ONAY:					
REV.	AÇIKLAMA	TARİH	KONTROL	İMZA	

PLAN +8.00 DÖŞEME SAC YERLEŞİM

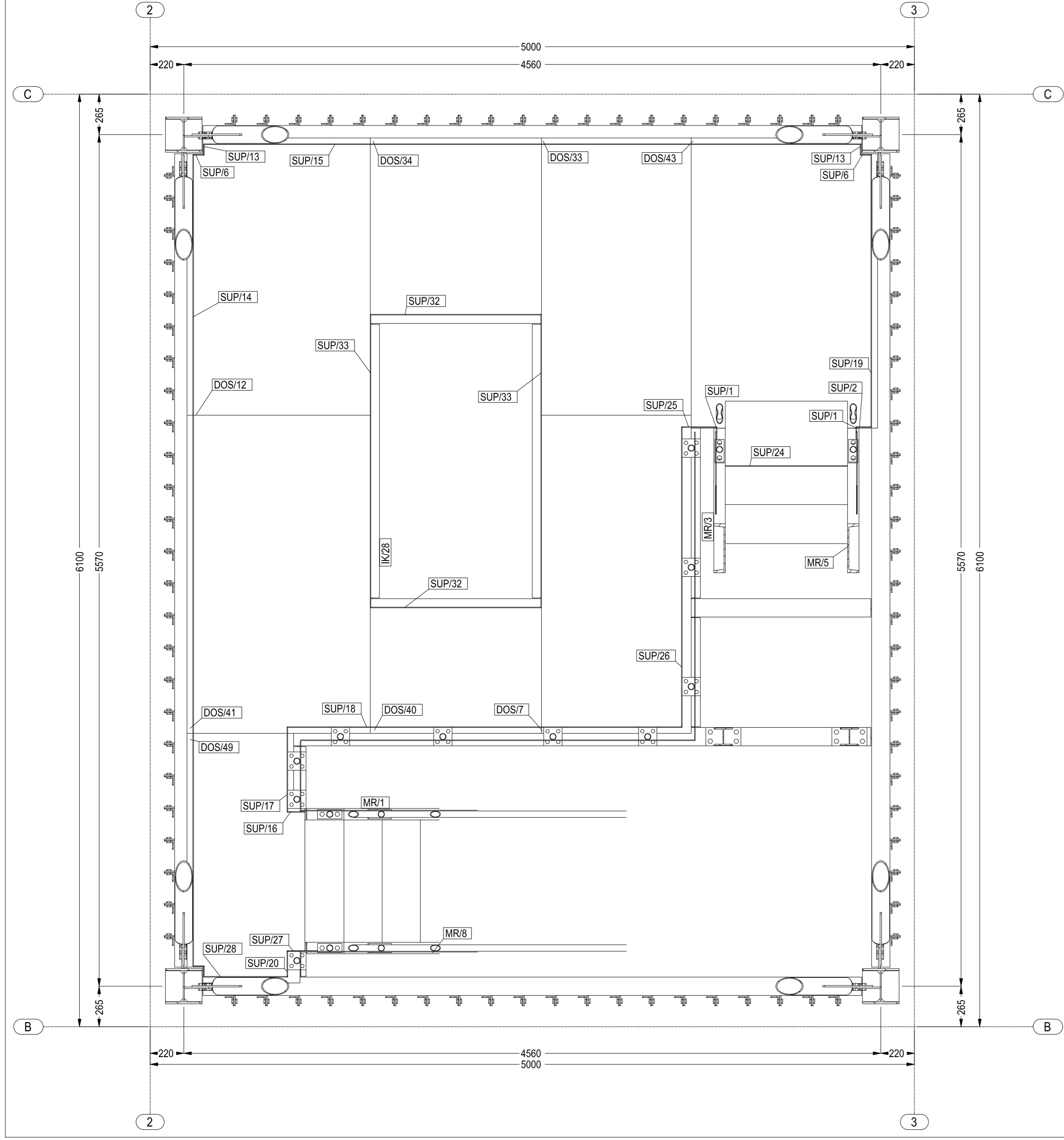

PLAN +8.00 ÇELİK YERLEŞİM

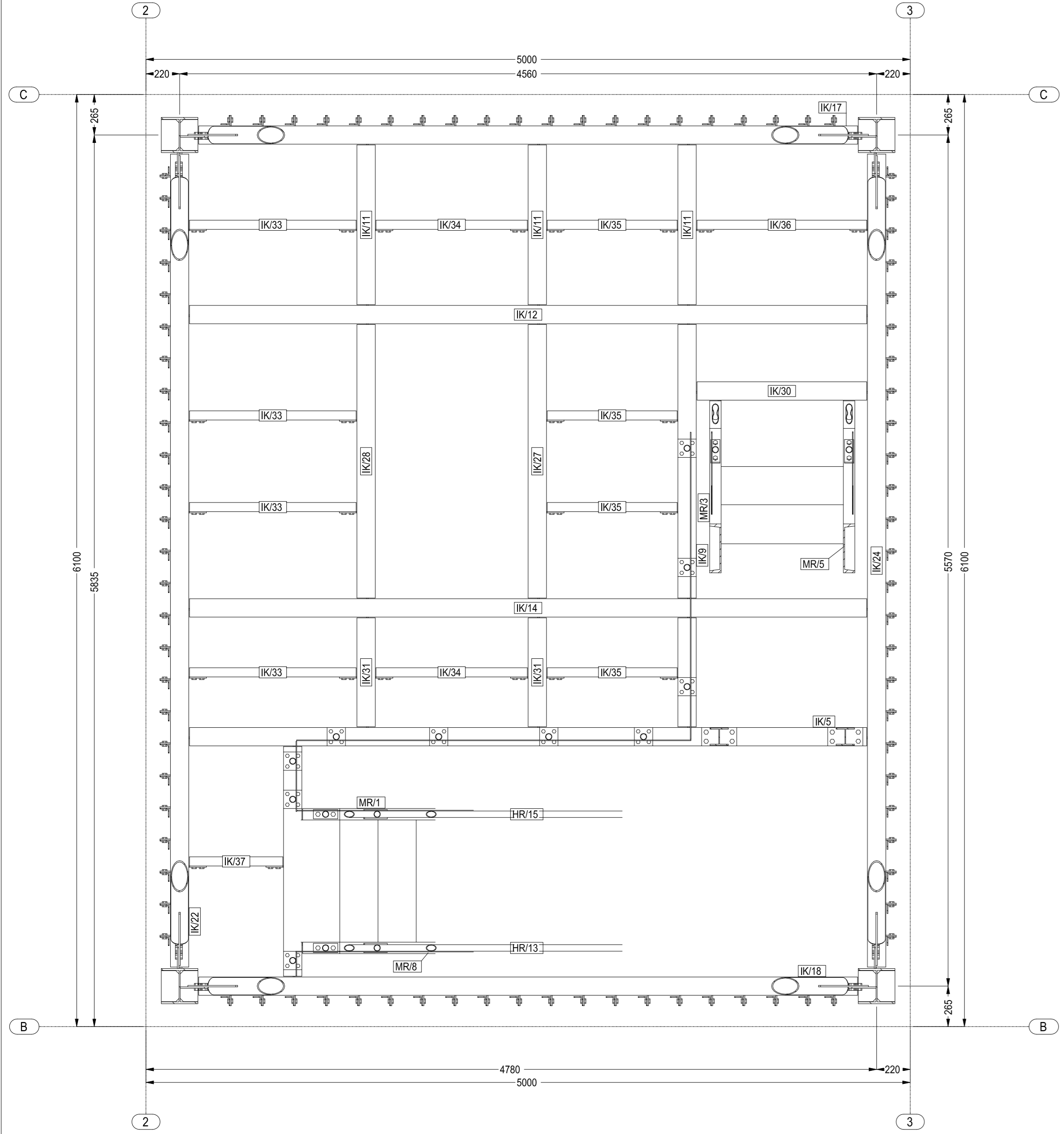

ÇATI DISPOZİSYON

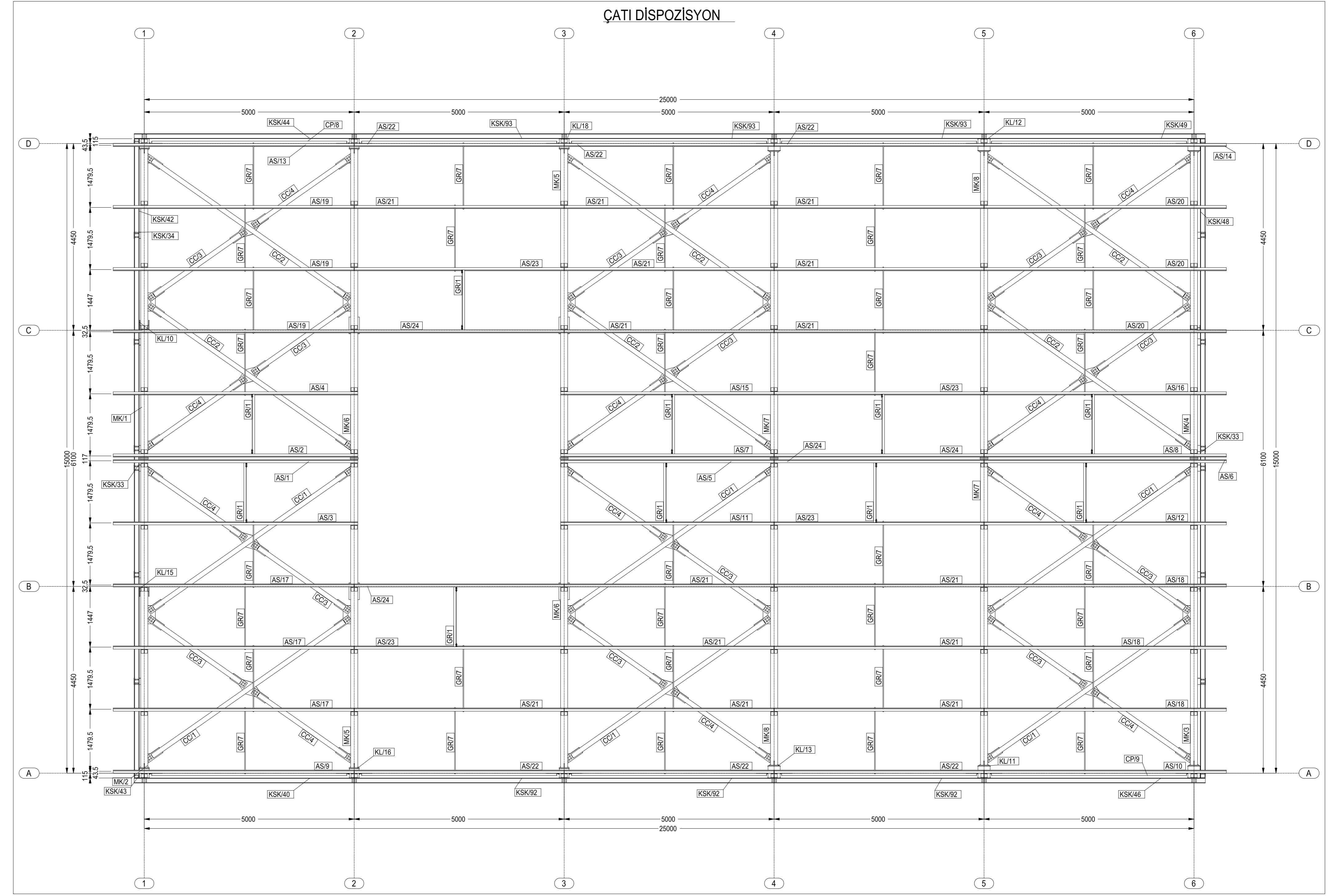

				KAŞE-İMZA
--	--	--	--	-----------

 <p>BurTem İnşaat Taahhüt Proje ve Müh. San. Ltd. Şti. Tel : +90 216 349 98 82 Fax : +90 216 349 93 59 ATAŞEHİR / KADIKÖY www.burtem.com info@burtem.com</p>	PROJE	ÖNVAN	ADI SOYADI	KAŞE-İMZA
	YAPAN	YÖK.İNŞ.MDH.	_____	
	ÇİZEN	YÖK.İNŞ.MDH.	_____	
	KONTROL	YÖK.İNŞ.MDH.	_____	

PAFTA NO :	08	PROJE ADI :	
ÖLÇEK :	1/20		
TARİH :	??????????????		

PLAN +8.00 KOTU DÖŞEME SAC VE ÇELİK YERLEŞİMİ

İNCELEME:

ONAY:

REV.	AÇIKLAMA	TARİH	KONTROL	İMZA

				KAŞE-İMZA
--	--	--	--	-----------

 <p>BurTem İnşaat Taahhüt Proje ve Müh. San. Ltd. Şti. Tel : +90 216 349 98 82 Fax : +90 216 349 93 59 ATAŞEHİR / KADIKÖY www.burtem.com info@burtem.com</p>	PROJE	ÖNVAN	ADI SOYADI	KAŞE-İMZA
	YAPAN	YÖK.İNŞ.MDH.	_____	
	ÇİZEN	YÖK.İNŞ.MDH.	_____	
	KONTROL	YÖK.İNŞ.MDH.	_____	

PAFTA NO :	09	PROJE ADI :	
ÖLÇEK :	1/50		
TARİH :	??????????????		

ÇATI DISPOZİSYON PLANI

İNCELEME:

ONAY:

REV.	AÇIKLAMA	TARİH	KONTROL	İMZA

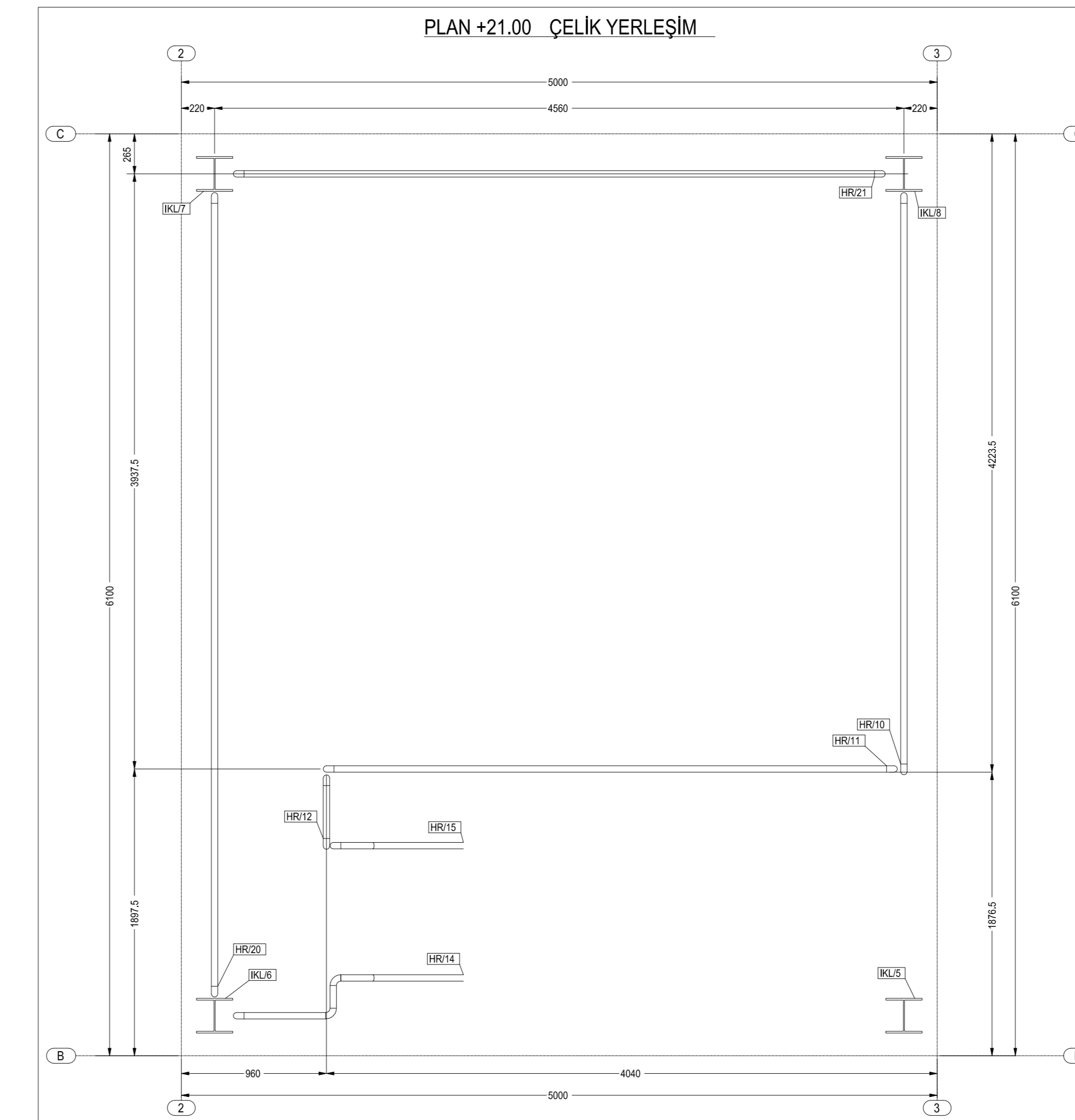
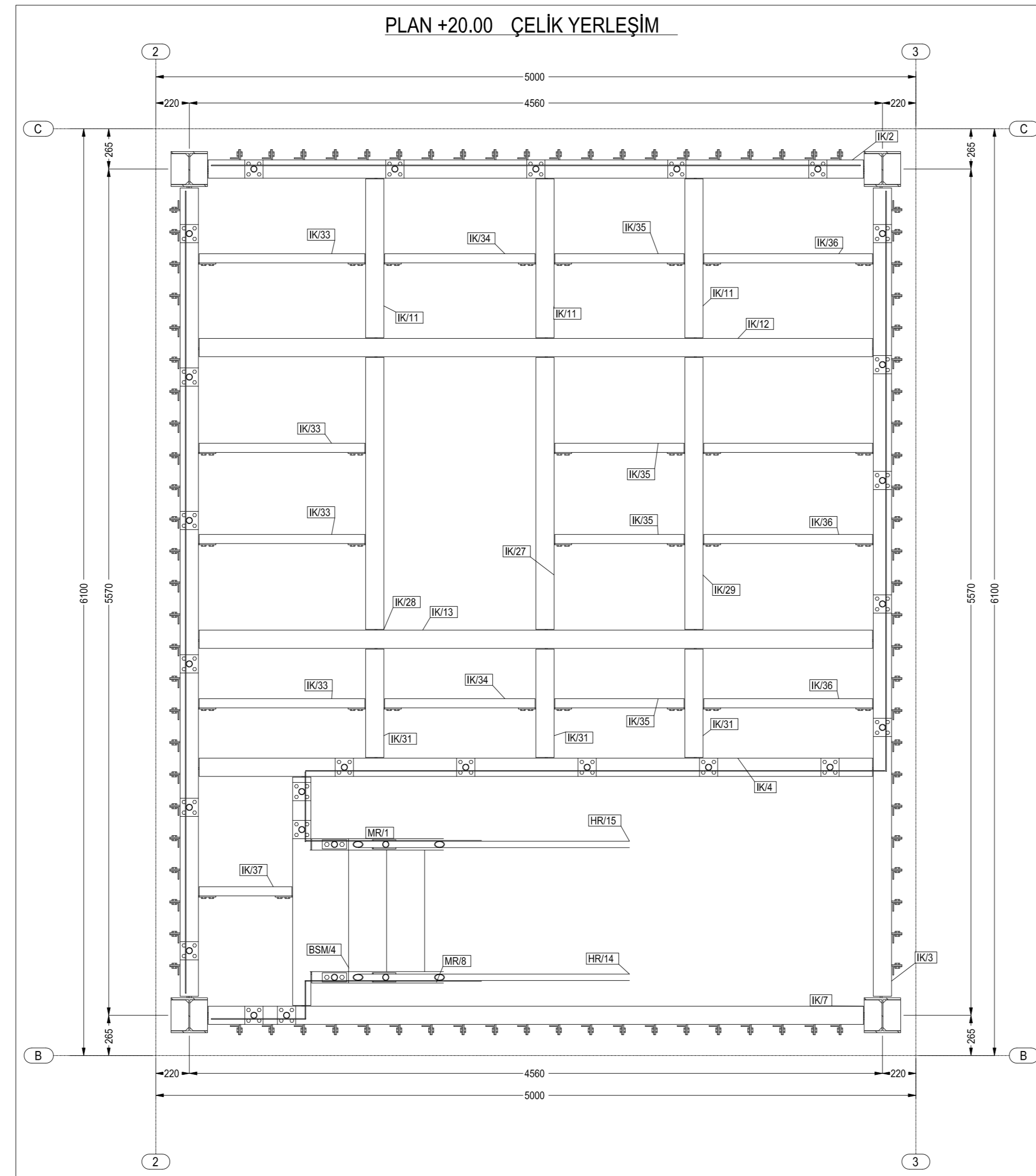
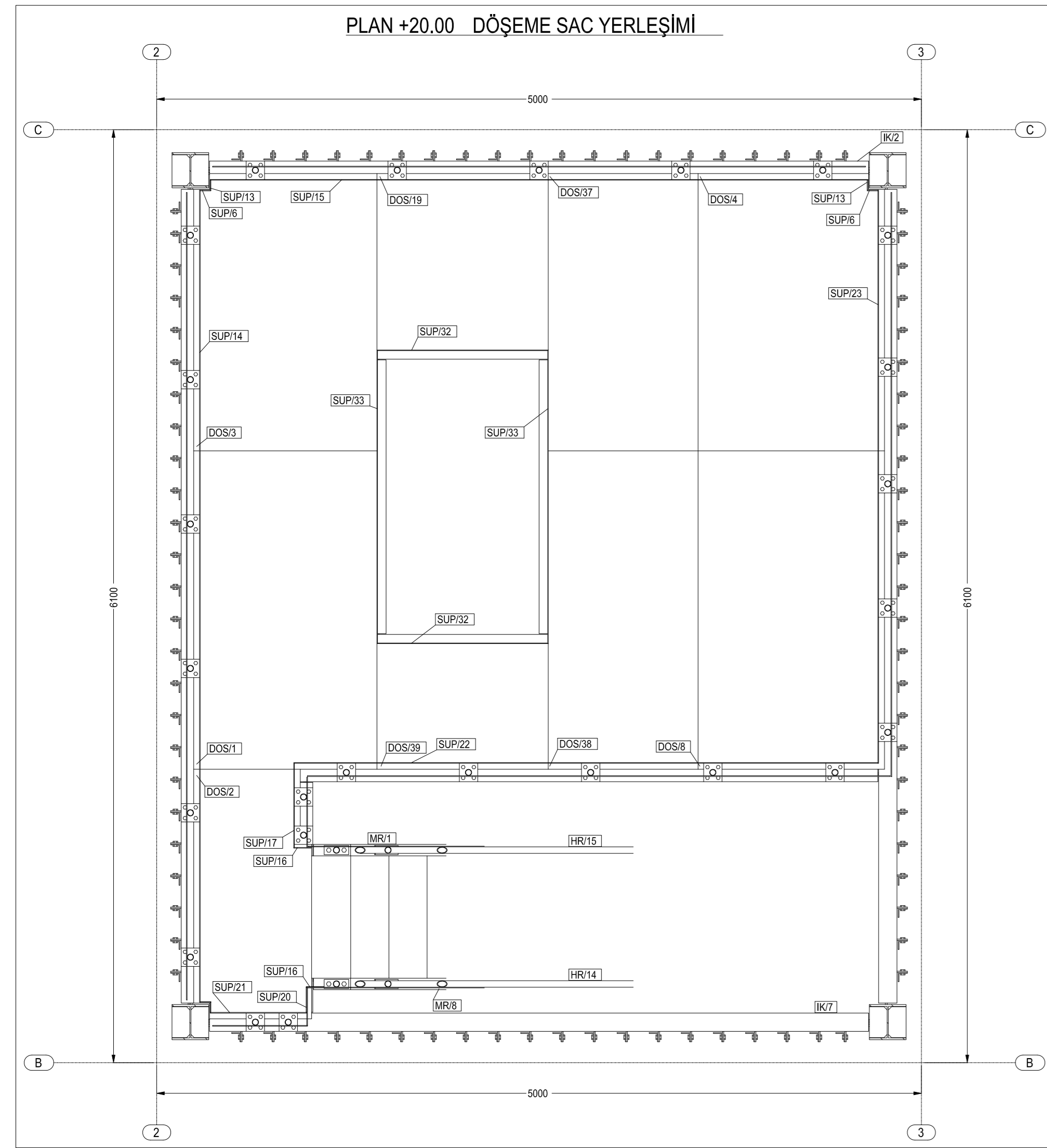
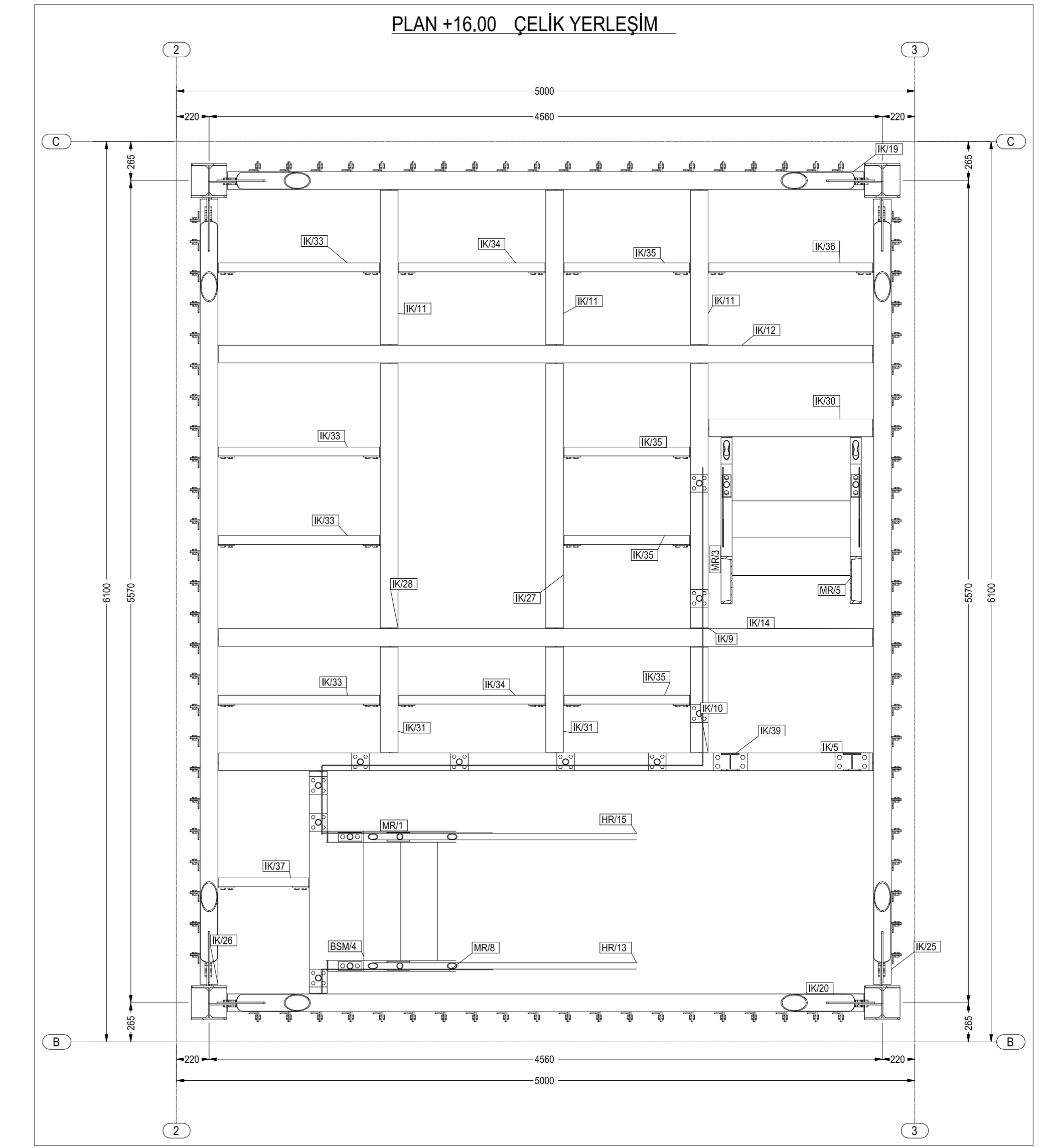
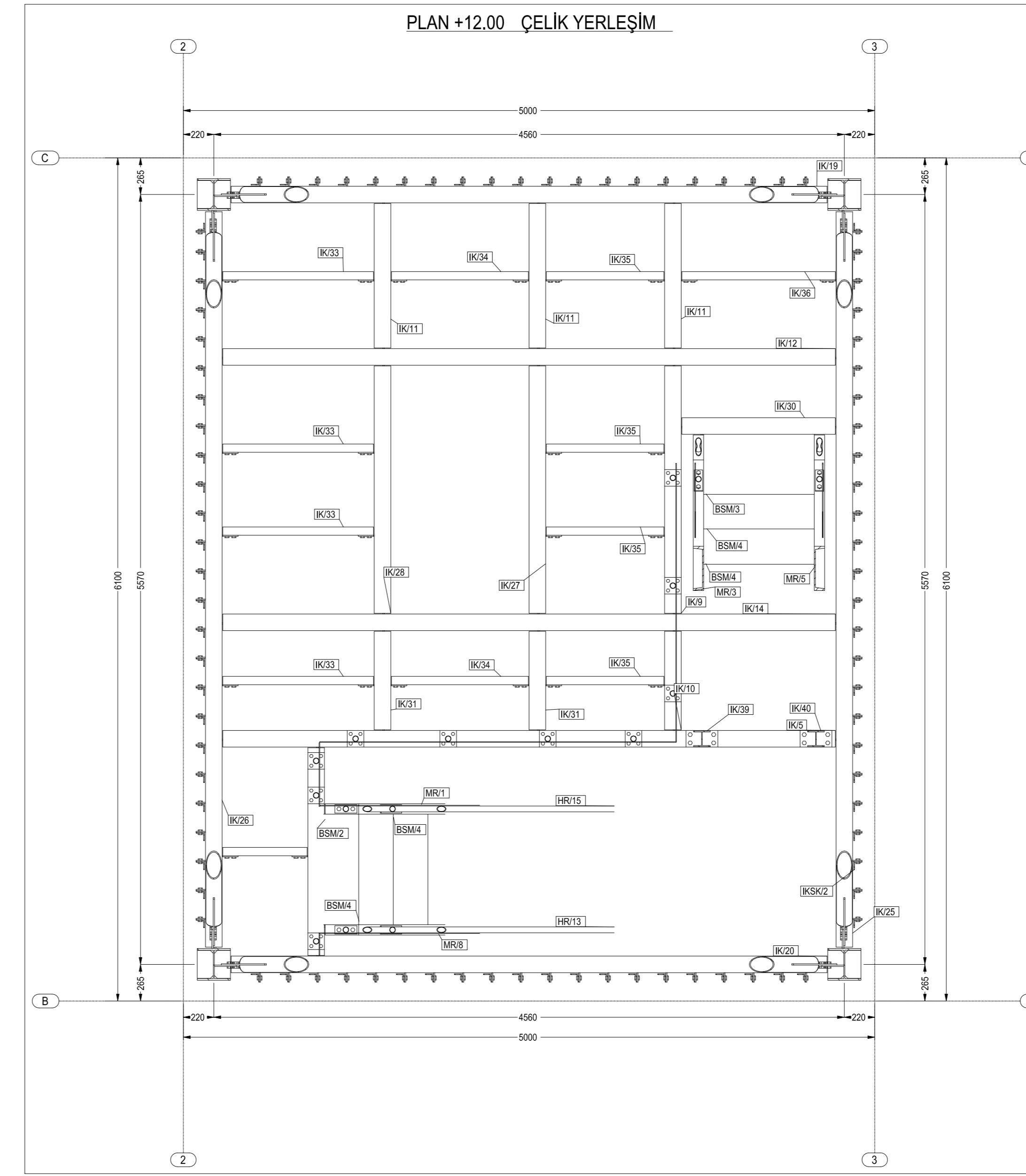
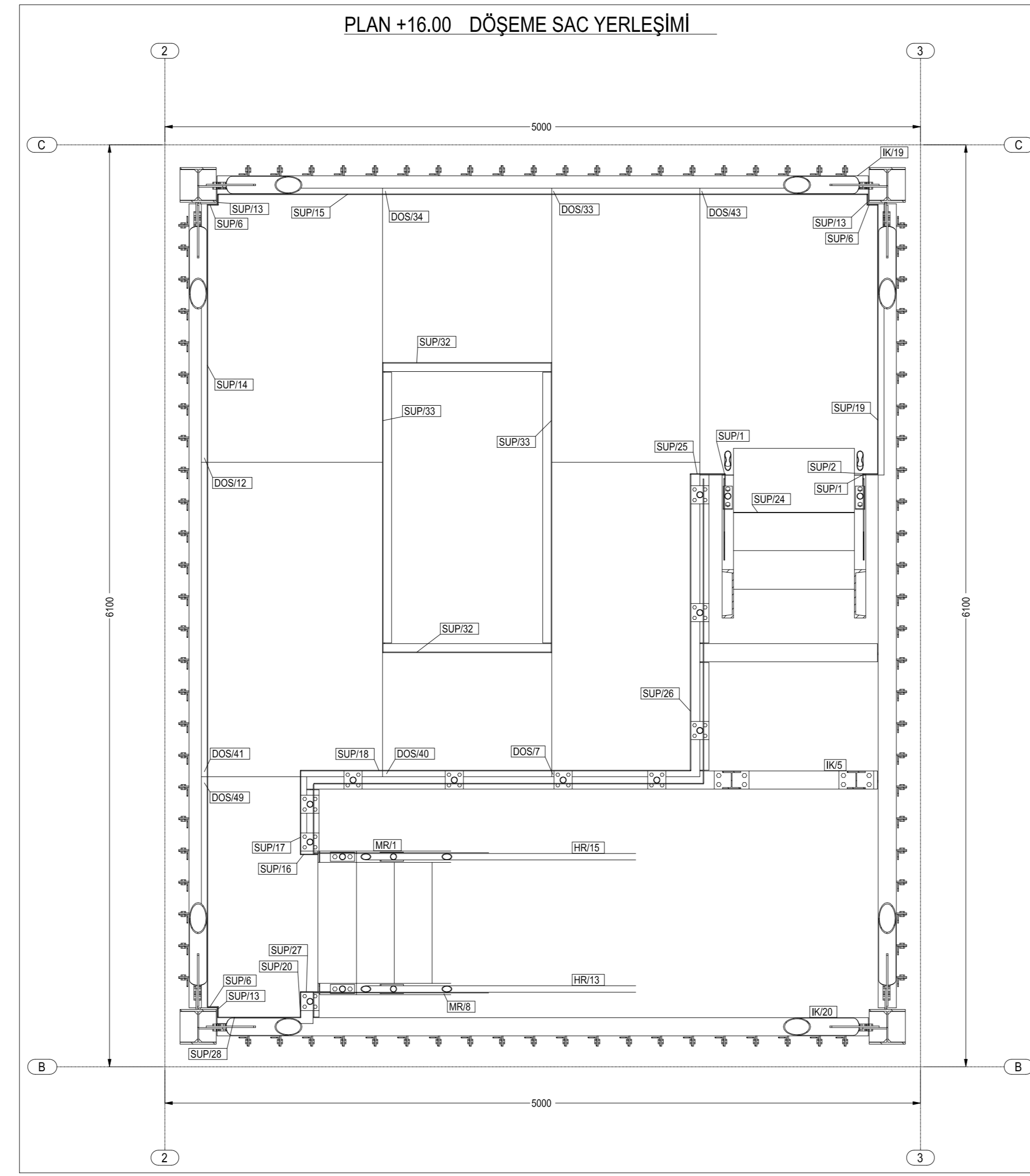
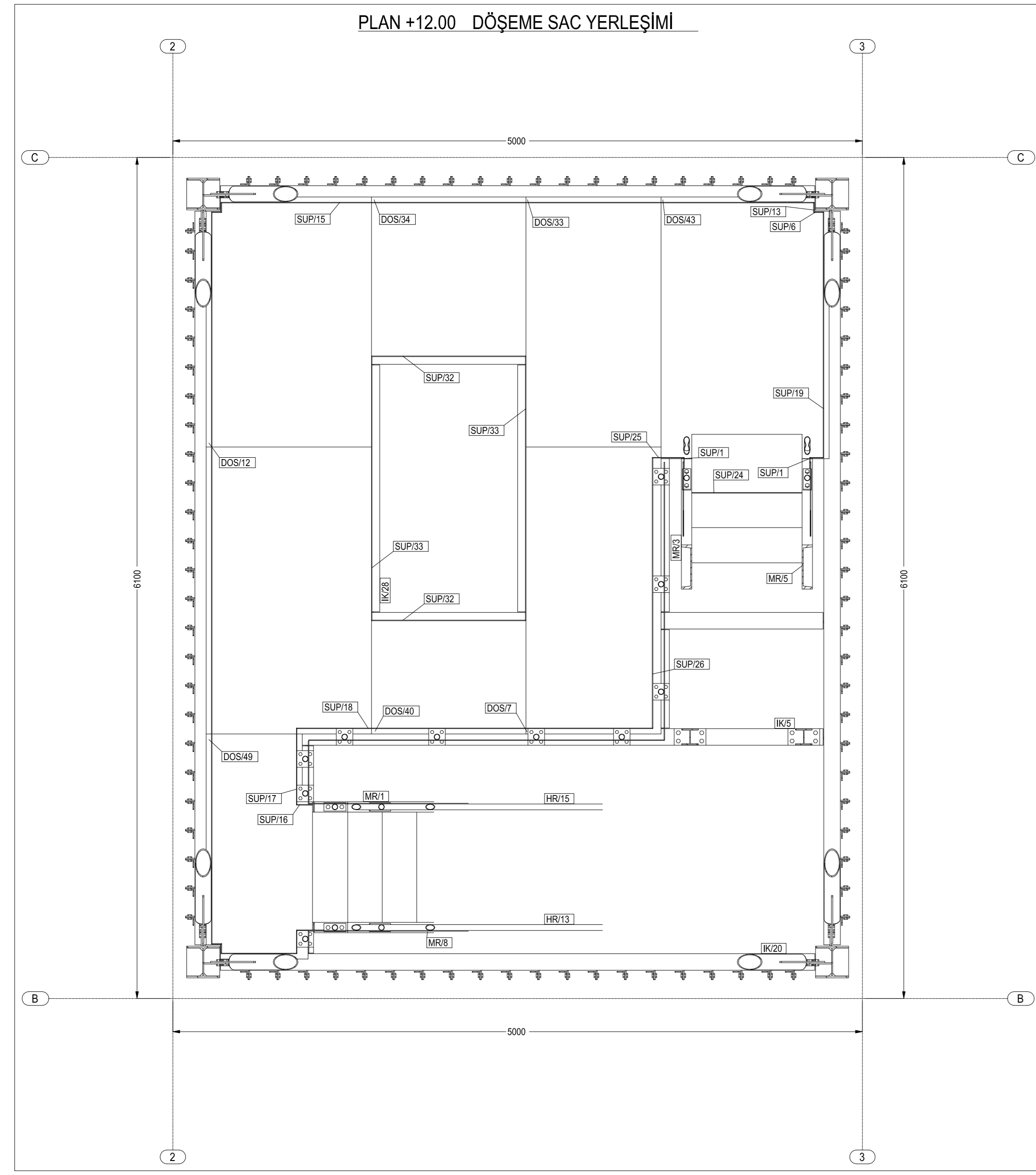

				KAŞE-İMZA
 BurTem <small>İnşaat Taahhüt ve Ticaret A.Ş. San. Ltd. Şti. Tel: +90 216 548 99 00 ATILGANLAR KATILIMCIYI</small>	PROJE	ÜNVAN	ADI SOYADI	KAŞE-İMZA
	YAPAN	YÖKLENGİ	_____	_____
	ÇİZEN	YÖKLENGİ	_____	_____
	KONTROL	YÖKLENGİ	_____	_____

PAFTA NO :	10	PROJE ADI :	
ÖLÇEK :	1/20		
TARİH :	????????????		
PAFTA ADI :	PLAN +12.00, +16.00, +20.00, +21.00 KOTU DÖŞEME SAC VE ÇELİK YERLEŞİMİ		

İNCELEME:			
ONAY:			
REV.	AÇIKLAMA	TARİH	KONTROL İMZA

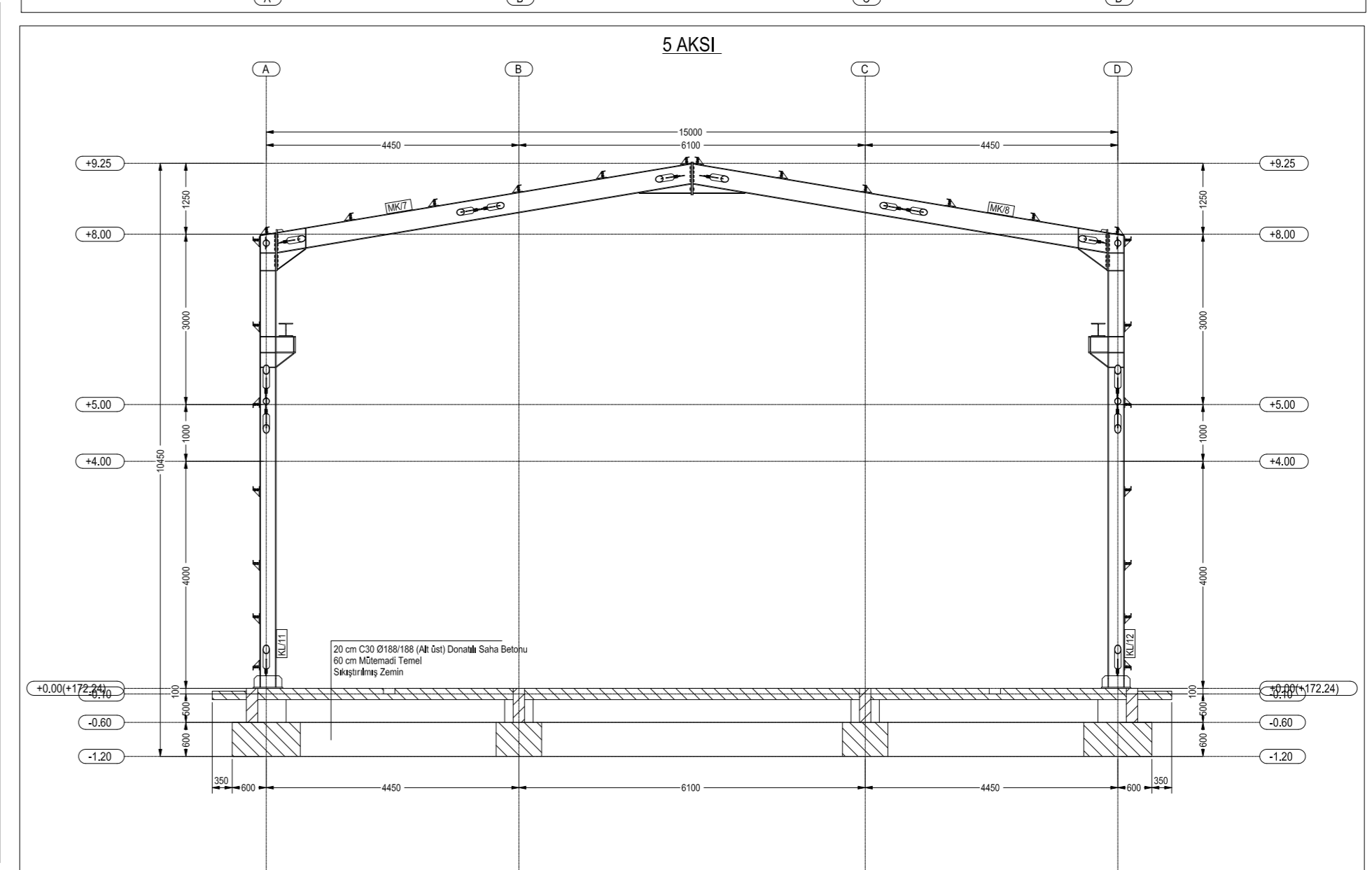
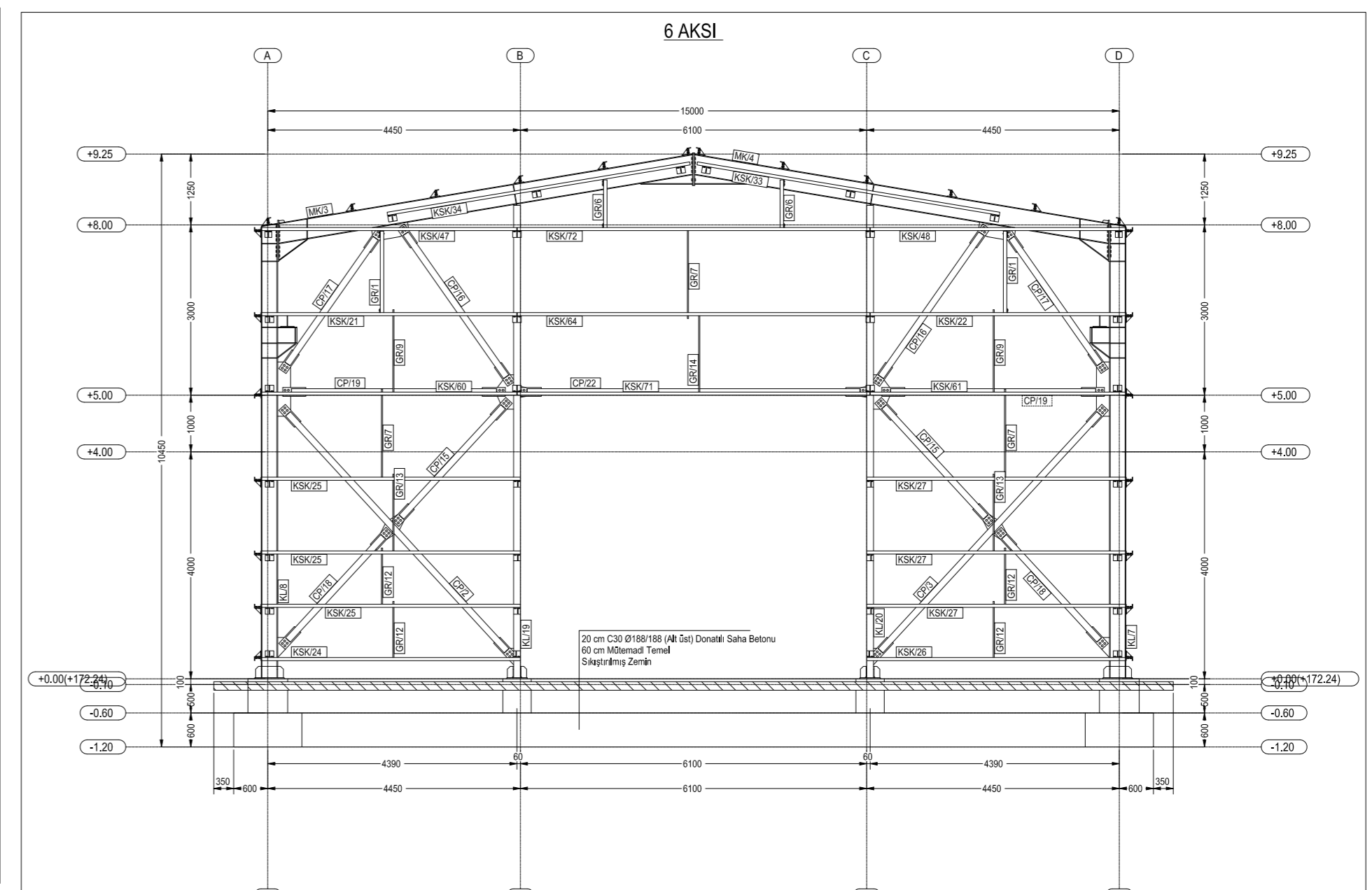
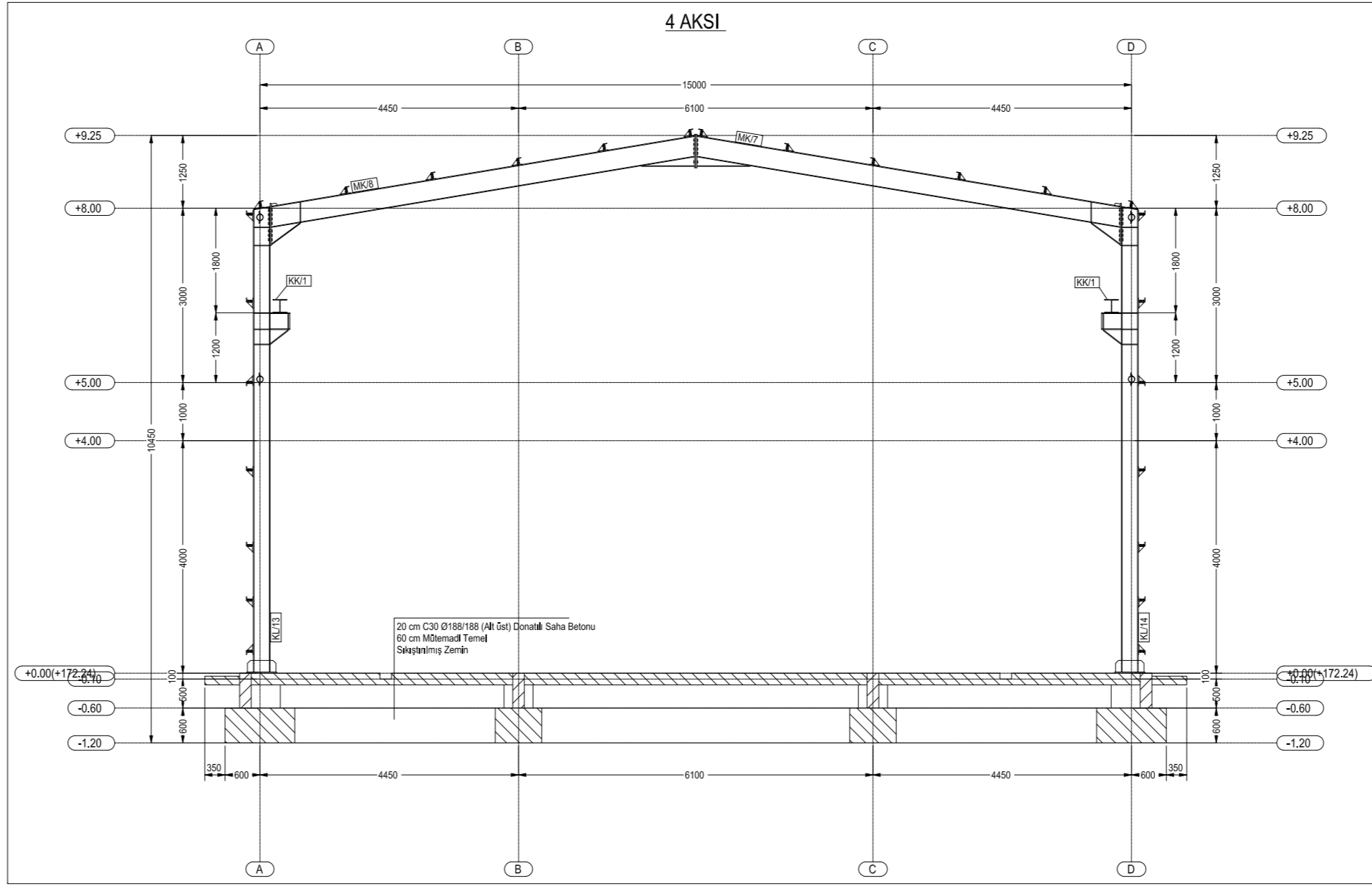
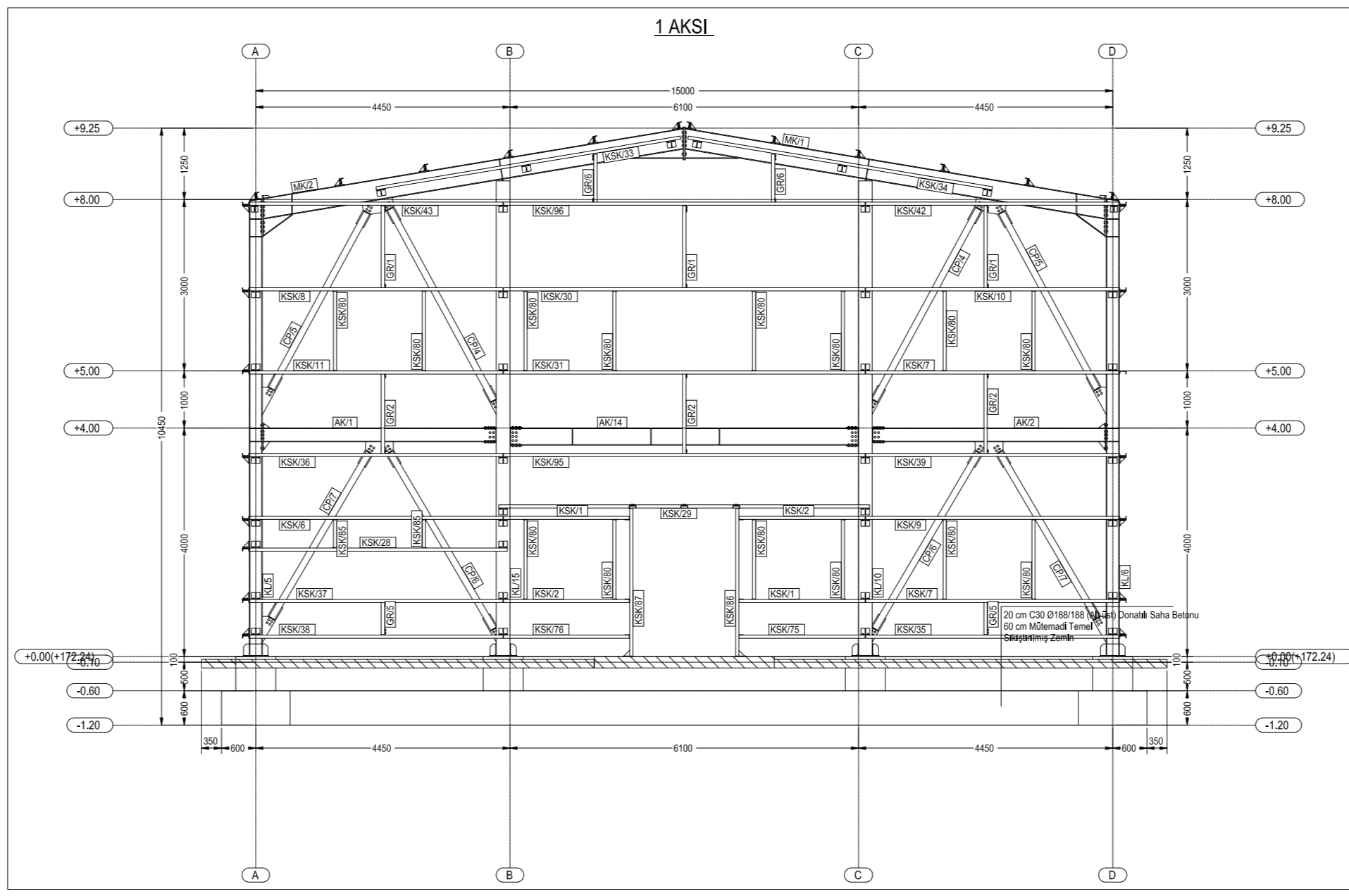
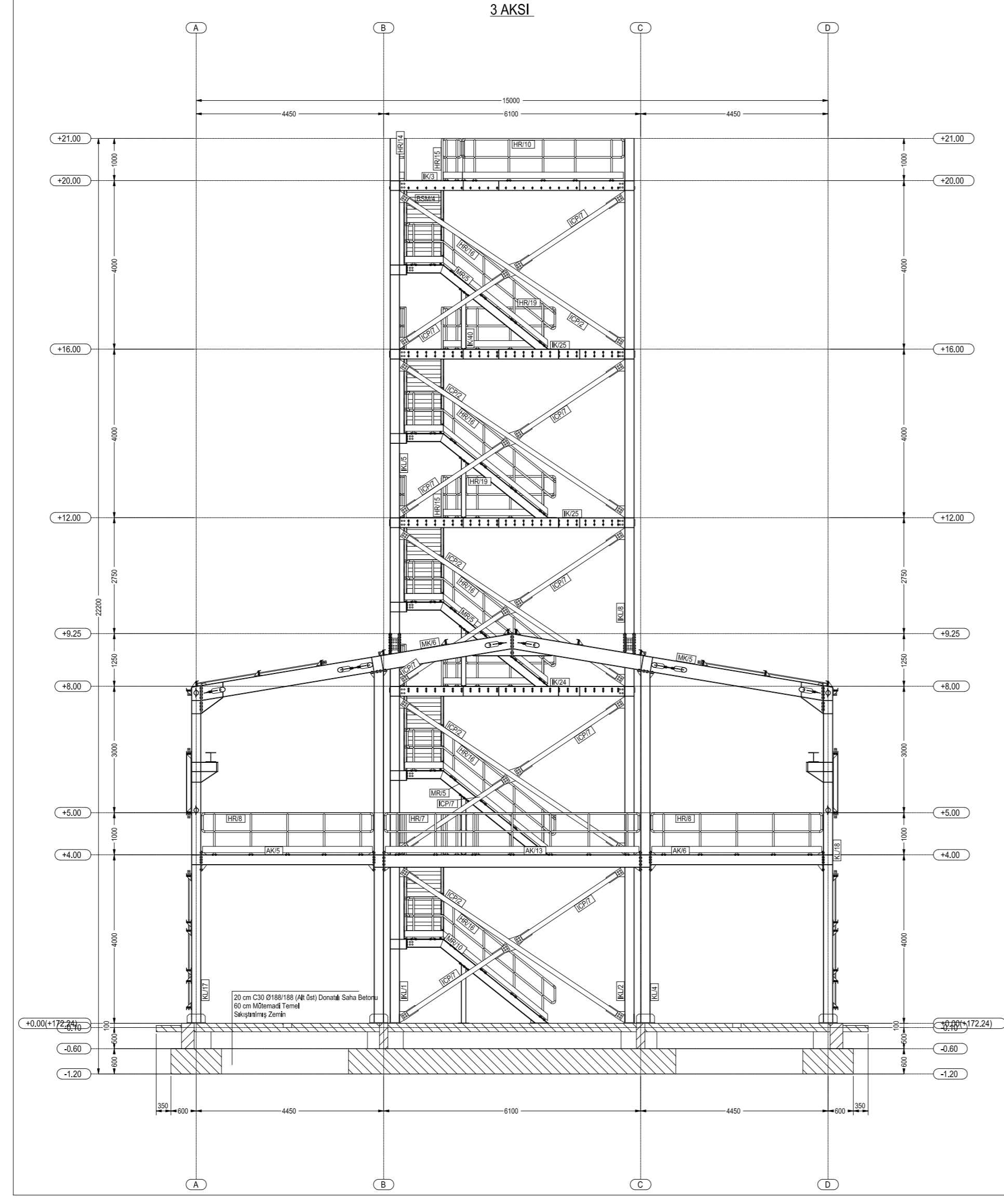
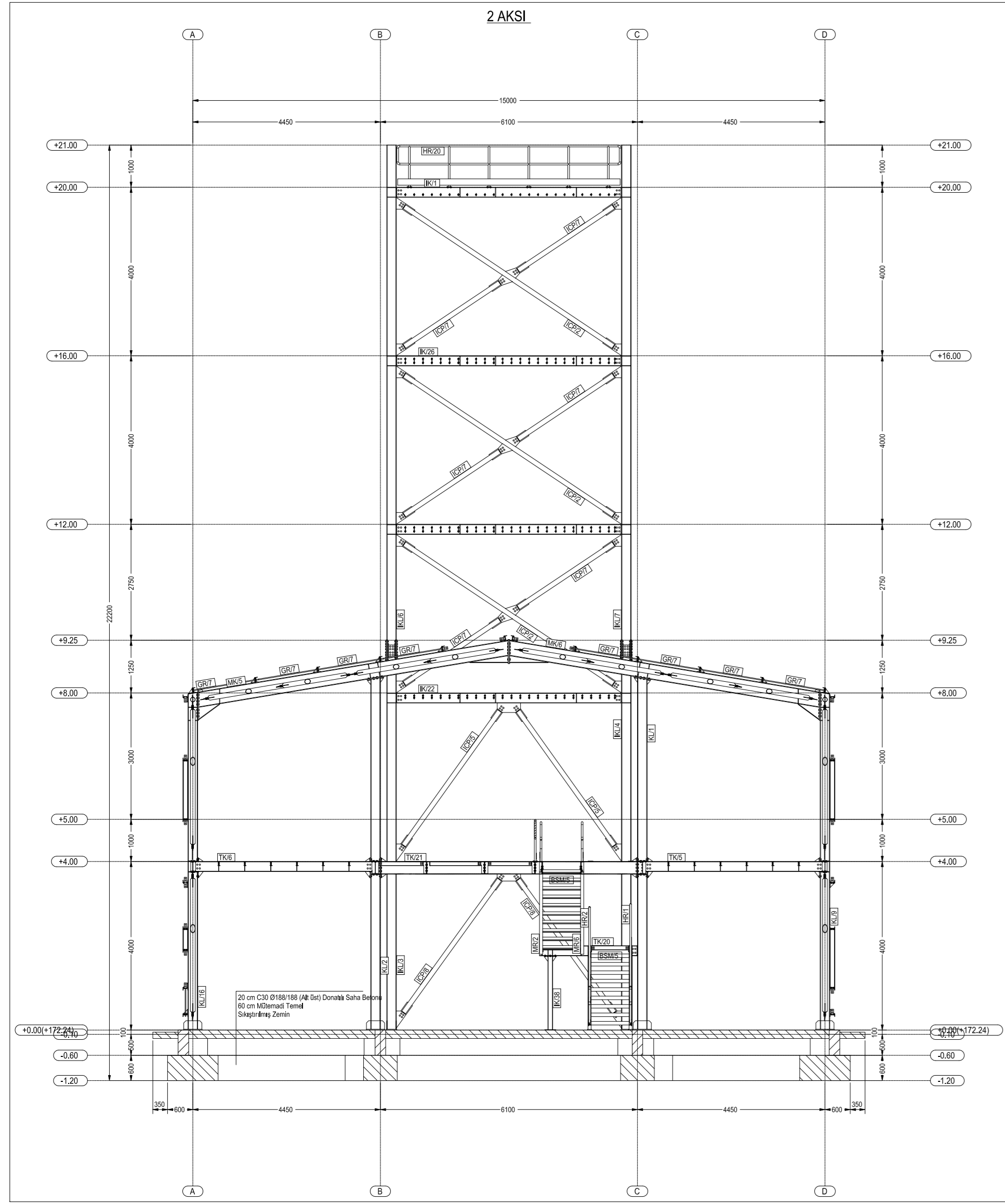

		KARŞI-KARŞI	
	PROJE	ÖN İSİM	AD SOYAD
	YAPAN	İNŞAATÇI	
	ÇİZEN	İNŞAATÇI	
	KONTROL	İNŞAATÇI	
PAFTA NO: 11	PROJE ADI:		
ÖLÇEK: 1/50			
TARİH: 2022/07/27			
PAFTA ADI:	1, 2, 3, 4, 5 VE 6 AKSI GÖRÜNÜŞLERİ		
İNCELEME:			
ONAY:			
REVİ	AÇIKLAMA	TARİH	KONTROL İMZA

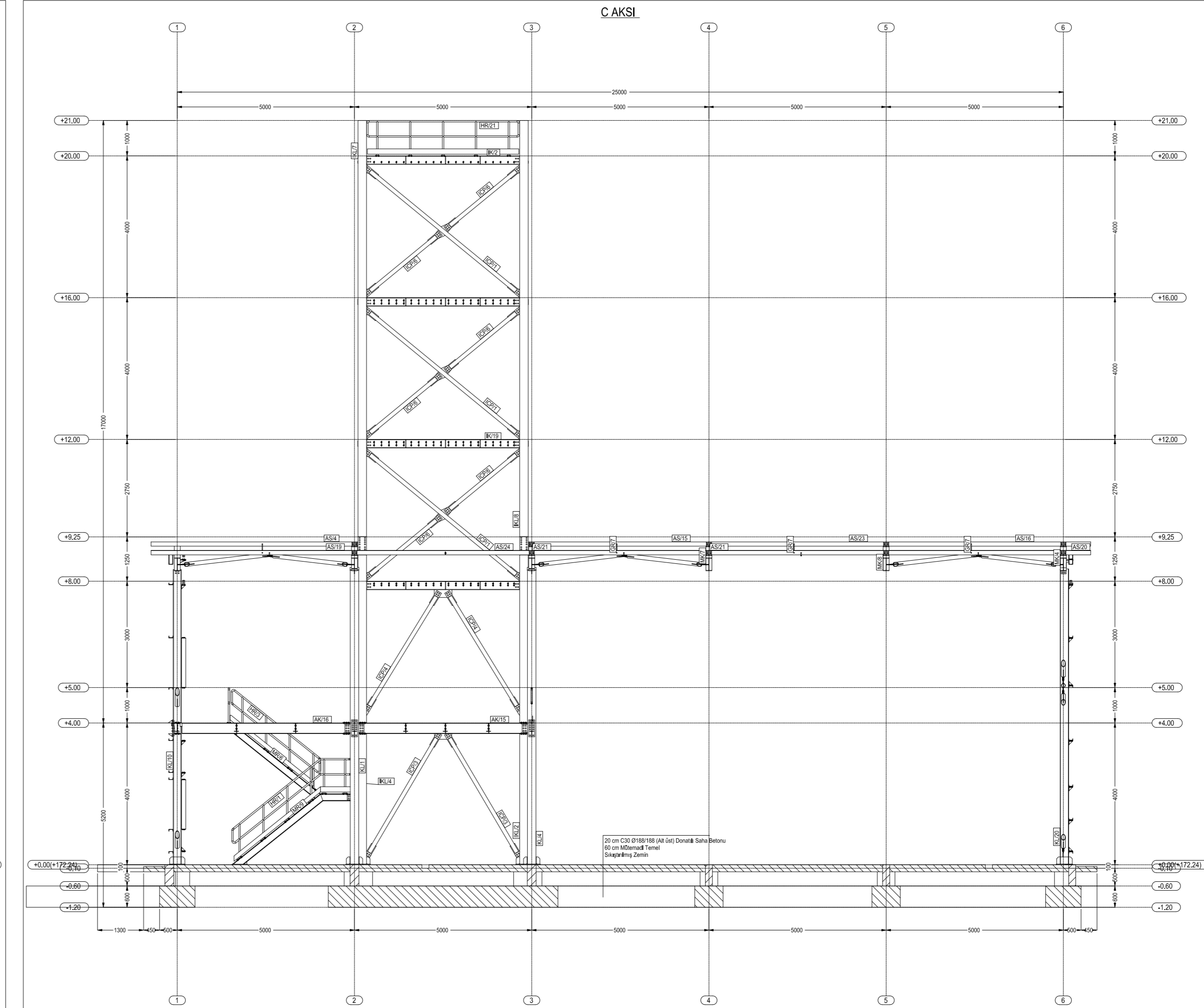
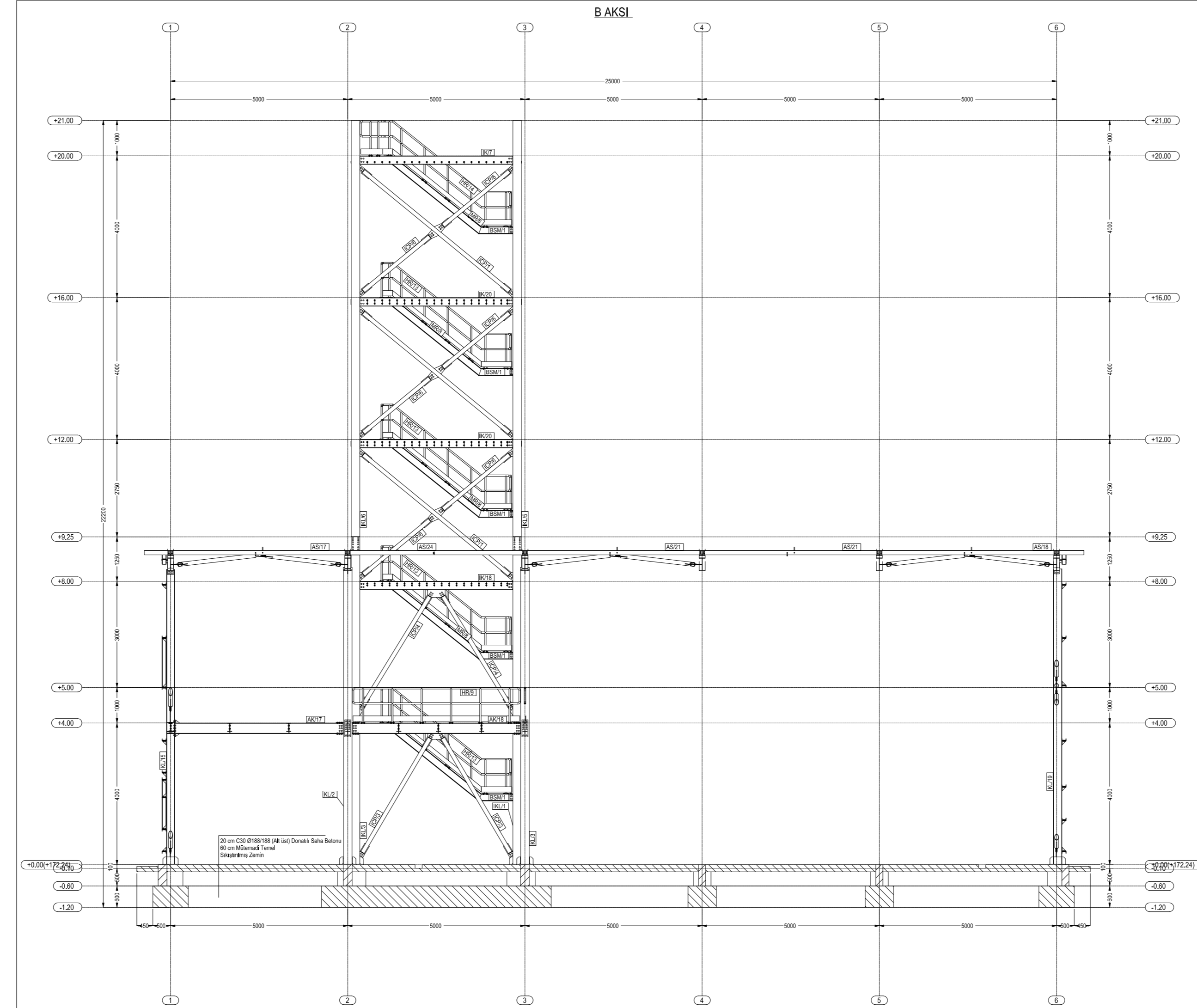
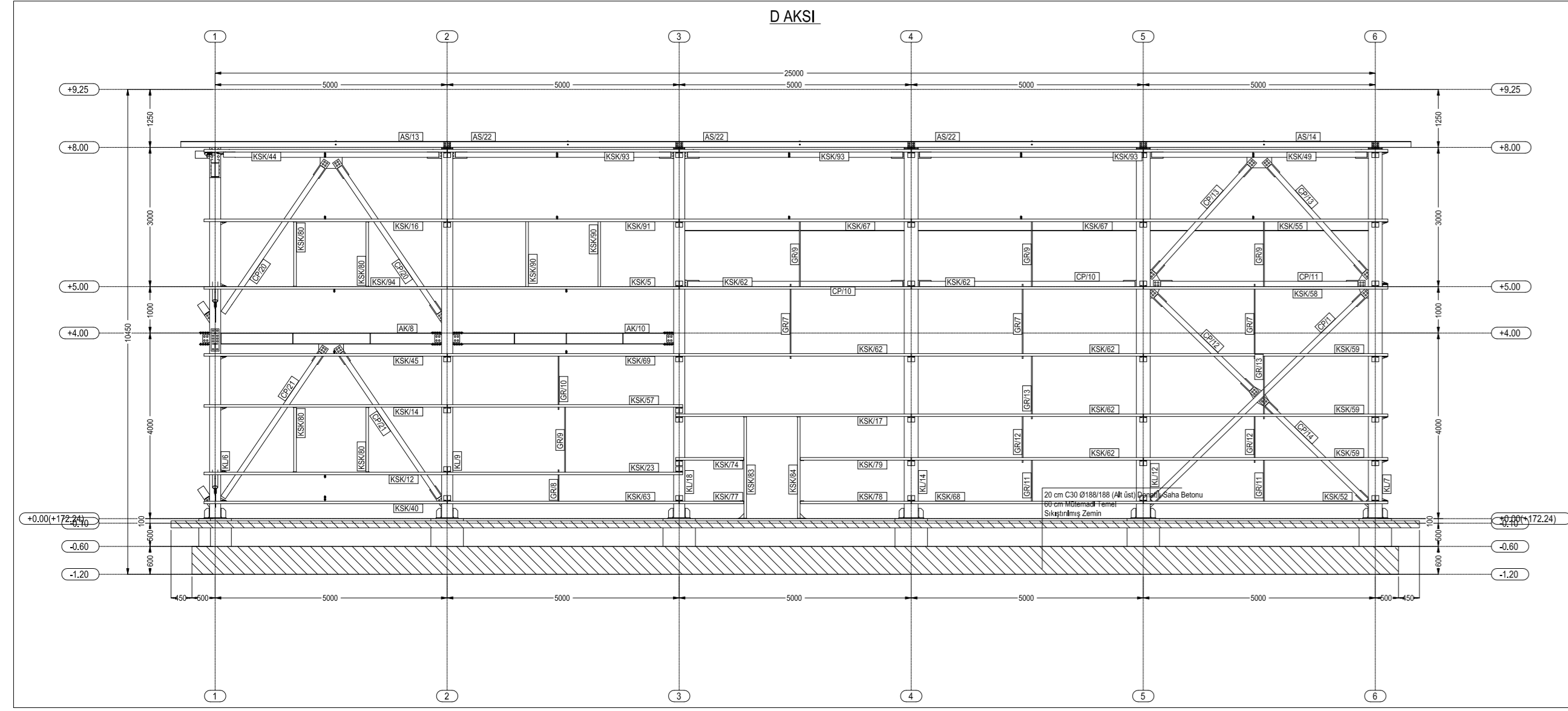
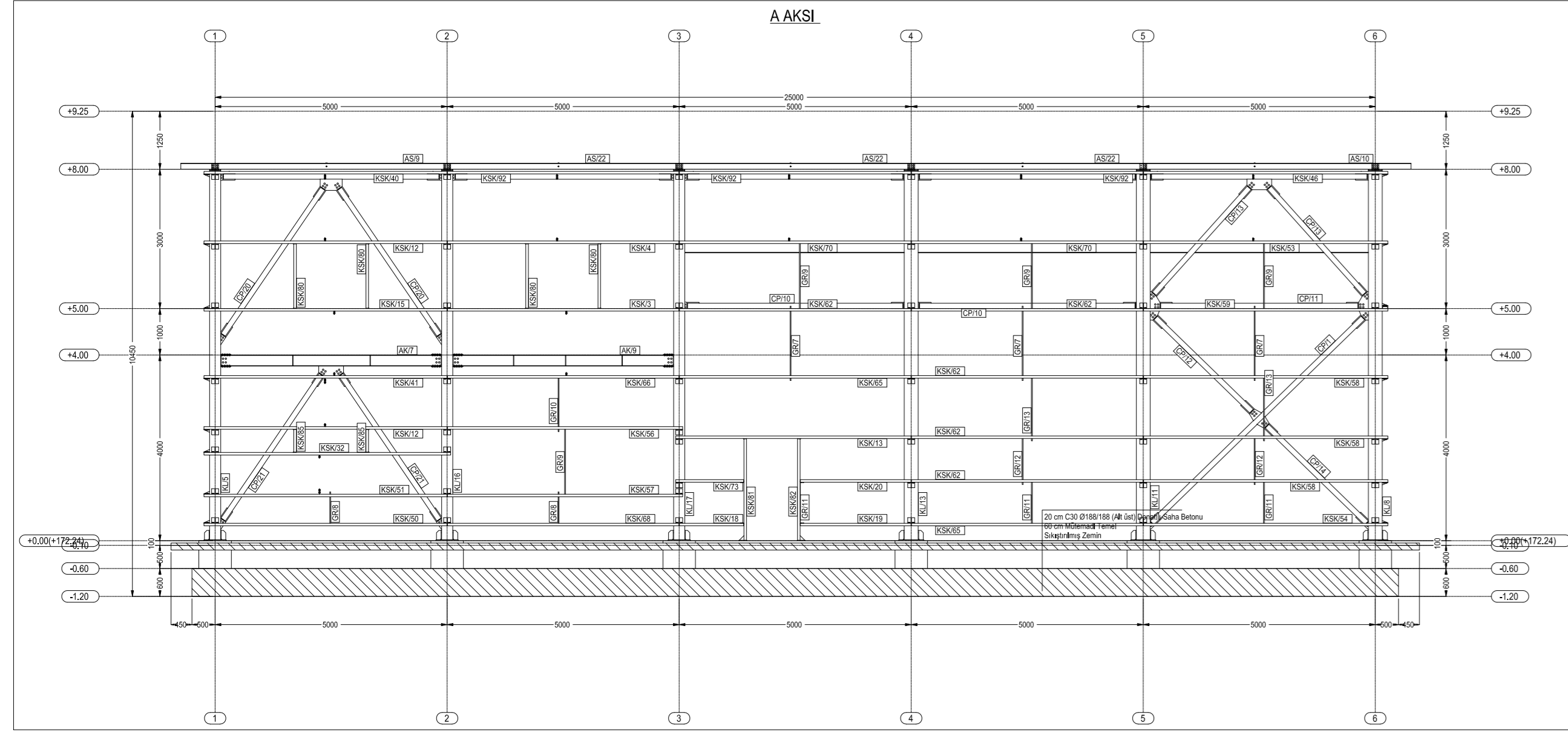

KARŞIYAKA		KARŞIYAKA	
		PROJE	İNŞAN
		YAPAN	AD SOYADI
		ÇİZEN	
		KONTROL	
PAFTA NO:	12	PROJE ADI:	
ÖLÇEK:	1/50		
TARİH:	777777777777		
PAFTA ADI:	A , B , C VE D AKSI GÖRÜNÜŞLERİ		
İNCELEME:			
ONAY:			
REV.	AÇIKLAMA	TARİHİ	KONTROL
			İMZA

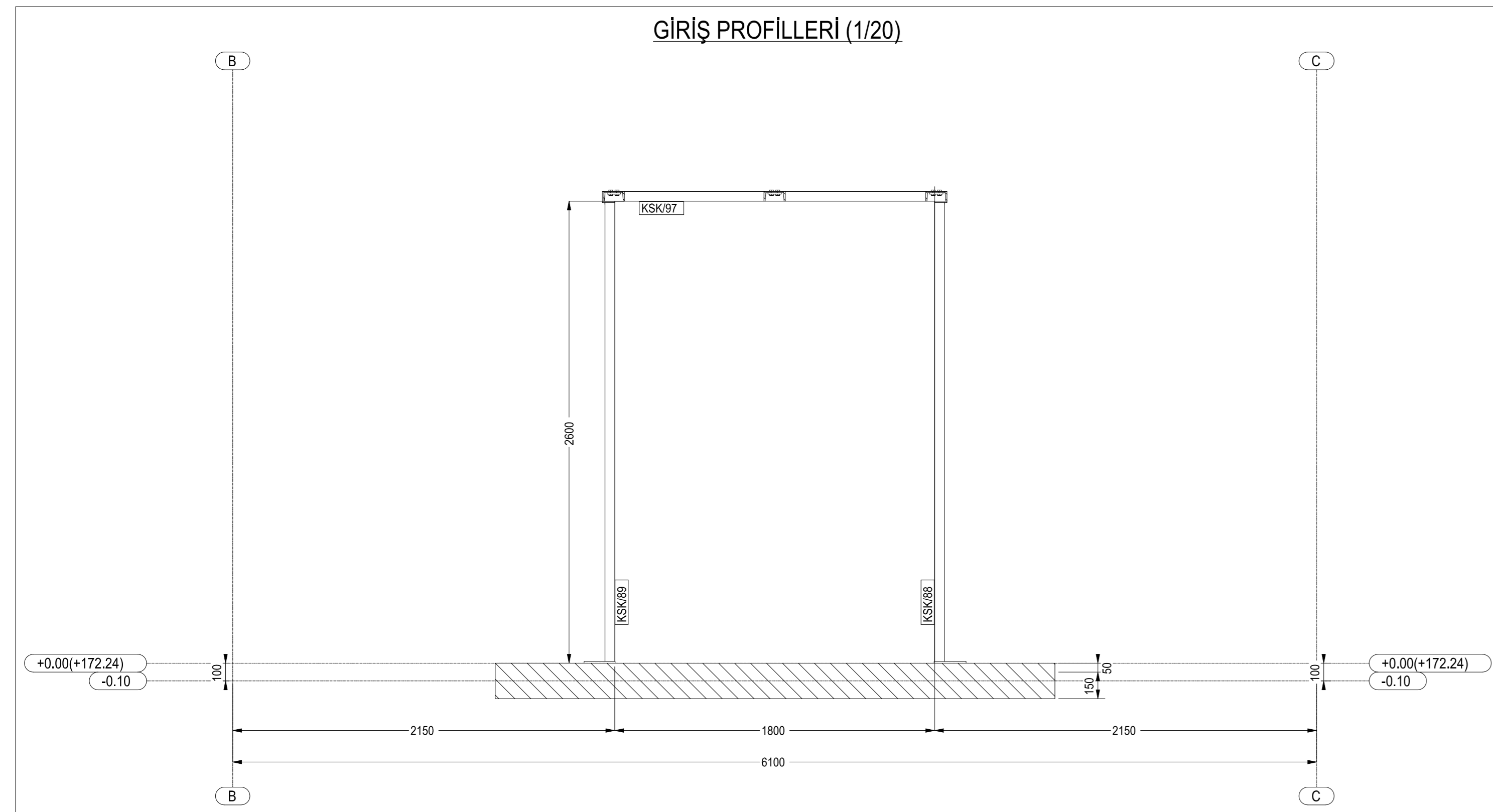
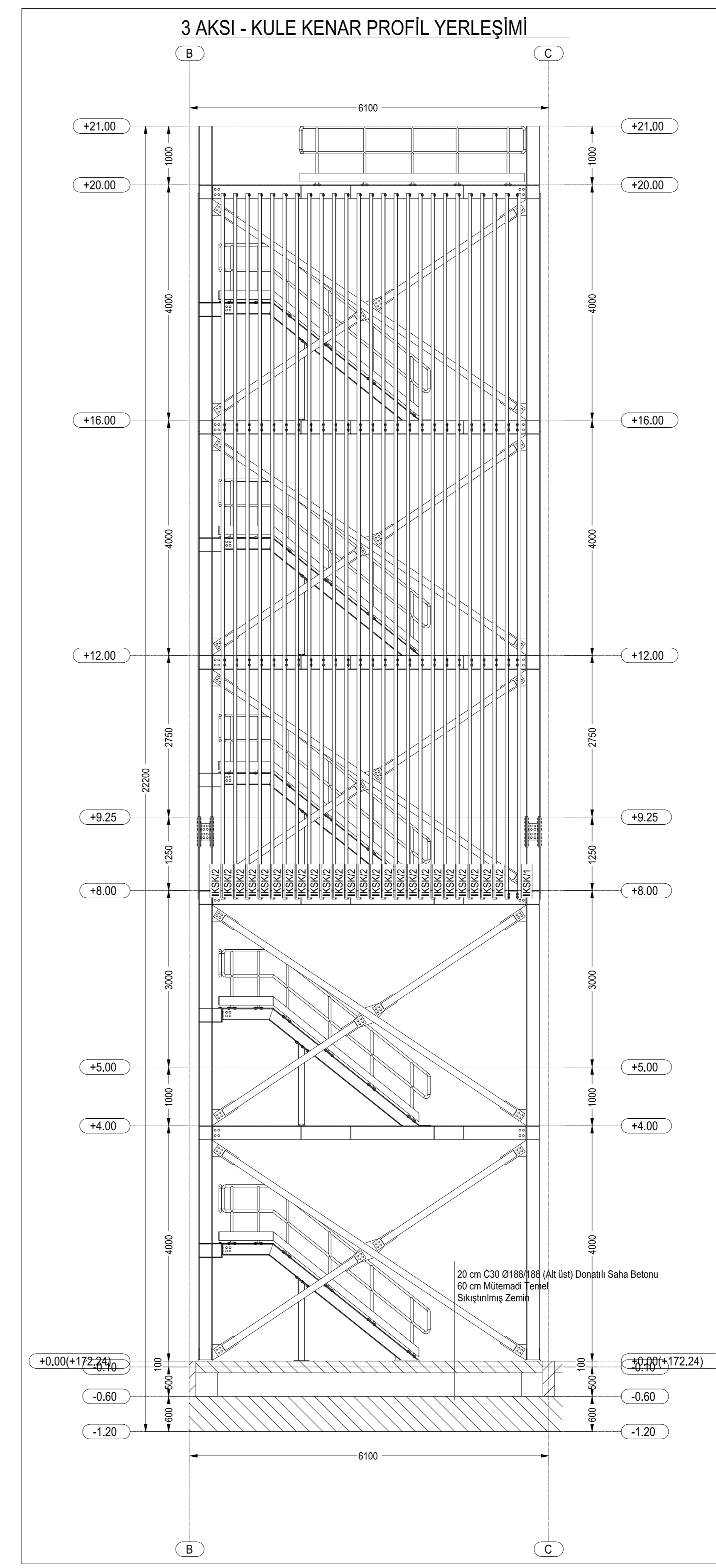
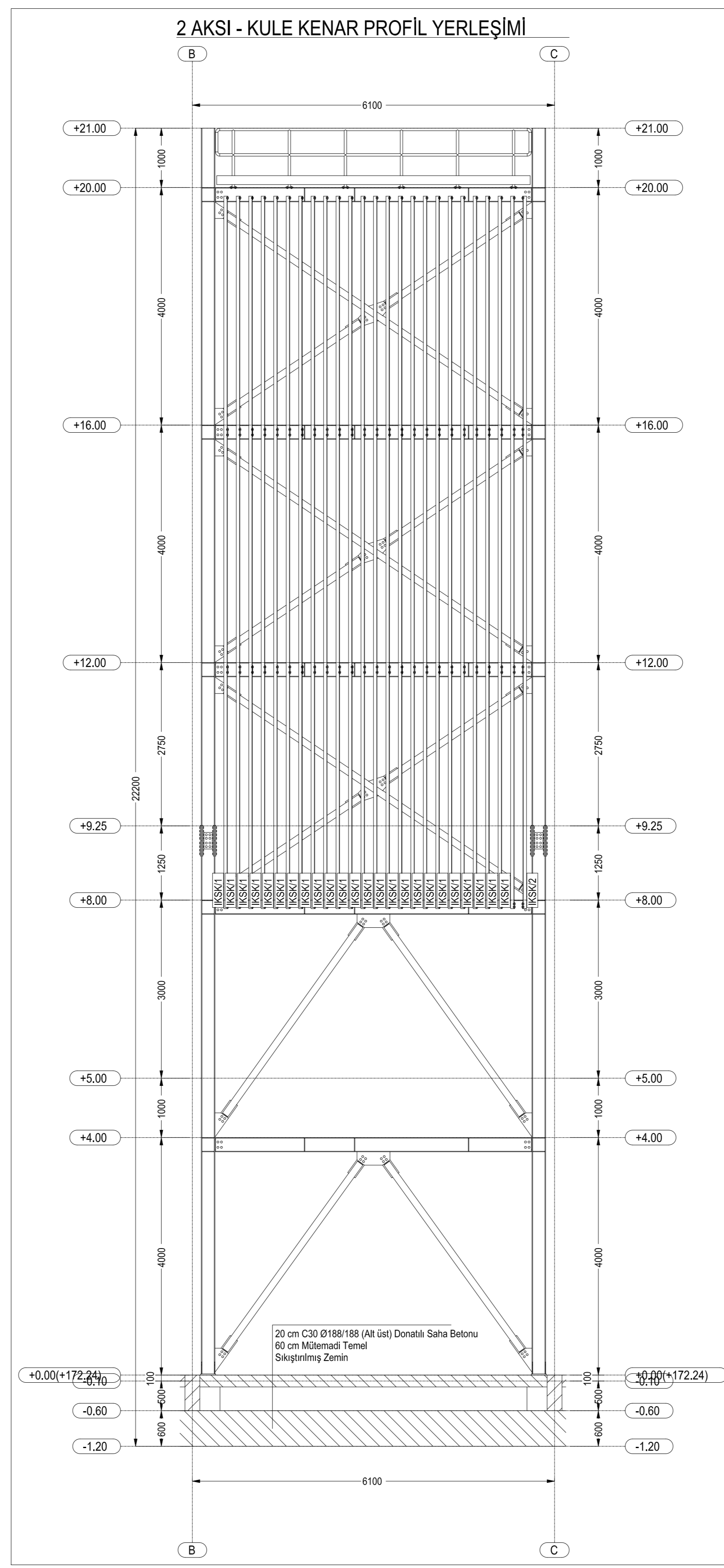
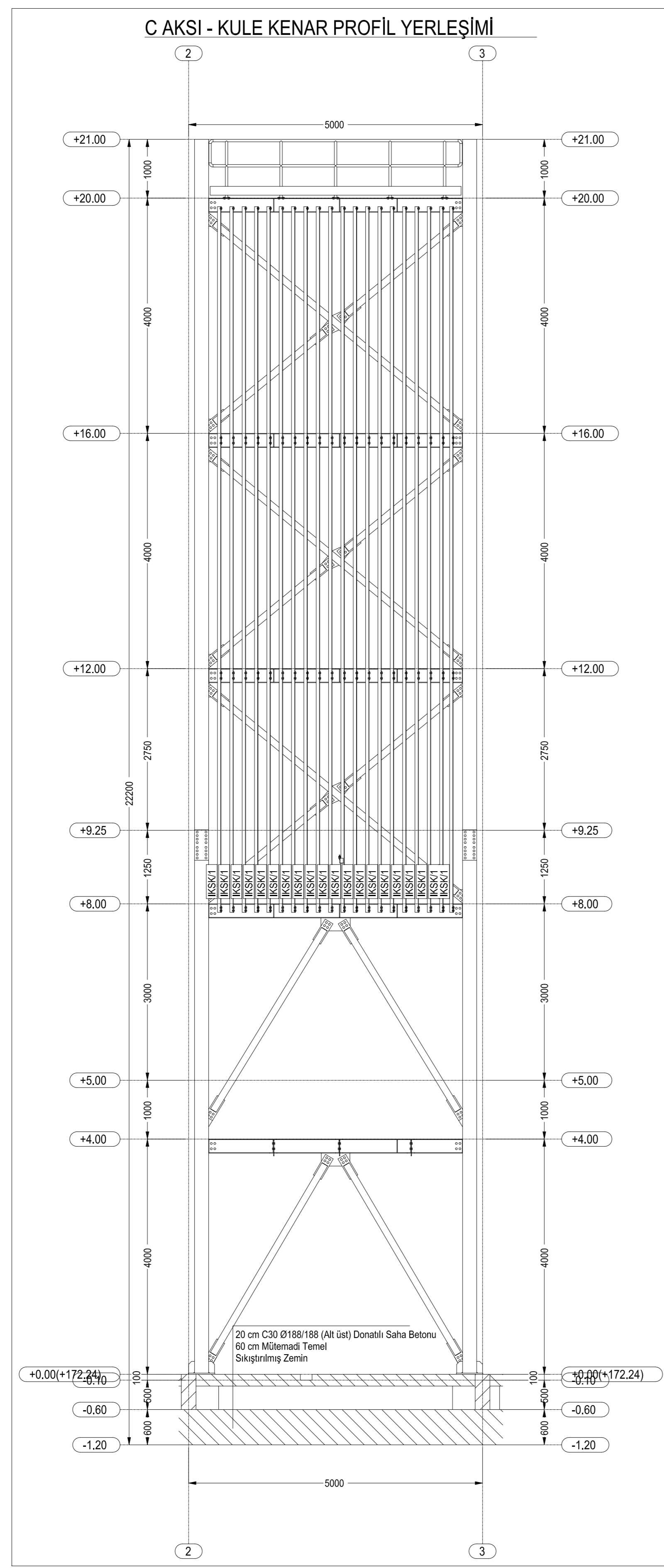
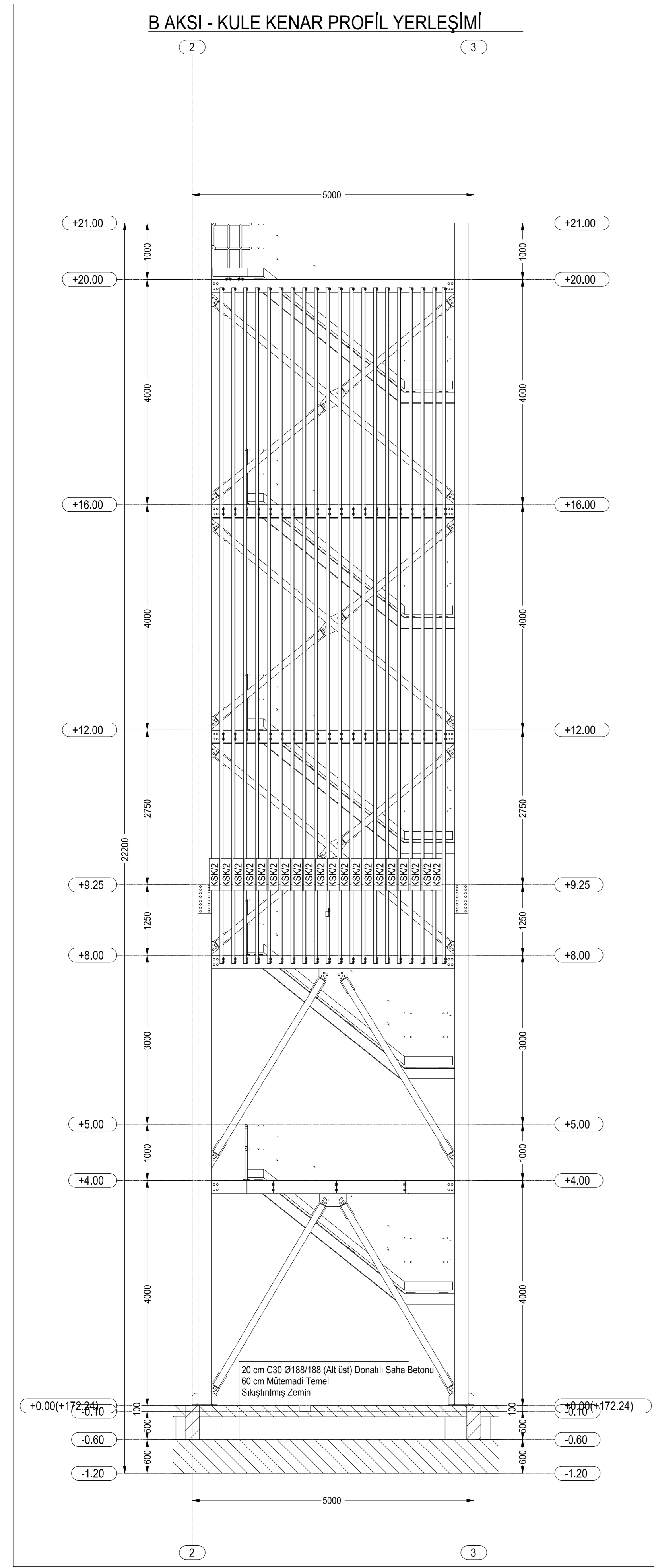

	KAŞE-İMZA
--	-----------

<p>BurTem <small>İnşaat İşleri, Proje ve Müh. San. Ltd. Şti. Tel: +90 216 549 98 82 Fax: +90 216 549 93 39 ATASEKİRLER KADIKÖY www.burtem.com.tr info@burtem.com.tr</small></p>	PROJE	ÜNVAN	ADI SOYADI	KAŞE-İMZA
	YAPAN	YÖK.İNŞ.MÜH.	_____	
	ÇİZEN	YÖK.İNŞ.MÜH.	_____	
	KONTROL	YÖK.İNŞ.MÜH.	_____	

PAFTA NO :	13	PROJE ADI :	
ÖLÇEK :	1/50-1/20		
TARİH :	????????????		
PAFTA ADI :	B , C , 2 VE 3 AKSI KULE KENAR PROFİL YERLEŞİMİ GİRİŞ PROFİLLERİ		

İNCELEME:	
ONAY:	

REV.	AÇIKLAMA	TARİH	KONTROL	İMZA